



AHŞAP İŞLEME MAKİNELERİ



hidtek

Hidtek 1987 yılında ülkemizin önemli endüstri şehirlerinden olan Bursa'da faaliyetine başladı.

Başlangıçta hidrolik, pnömatik malzeme satışı ve taahhüt işleri yapan firmamız, ilerleyen zamanda hızla gelişerek ithalat ve ihracat ile birlikte otomasyon ekipmanları ve pnömatik silindiri imalatını da faaliyet alanlarına dahil etti.

Markalaşma, pazarlama ve satış ağını geliştirme konularına da önem vererek **WINMAN** ve **FREEWAY** markalarını oluşturdu. Buna paralel olarak, yurtiçinde ve yurtdışında her geçen gün satış ağını genişletmeye devam etti.

Üretim konusunda kurduğu Ar-ge merkezi ile geleceğe ve sürekli gelişen teknolojiye bugüne kadar olduğu gibi bundan sonrada ayak uydurmak kararlılığındadır.

Üretim ve satışı yapılan malzemelerin genel kullanım alanları şunlardır:

- Otomotiv sanayi
- Makina sanayi
- Ambalaj makineleri
- PVC işleme makineleri
- Kaldırma makineleri (asansör, lift)
- Sac işleme makineleri
- Hidrolik presler
- İş makineleri
- Tarım makineleri
- Özel amaçlı makina ve aparatlar

Firmamız, katalogta yayınlanan resim, ölçü ve diğer değerleri değiştirme hakkına sahiptir.

Hidtek started its operations in 1987 in Bursa which is one of the most important industrial cities of our country.

At the beginning, our company was engaged in hydraulic, pneumatic material sales and contract works. Later on, it has been developed rapidly, so included production of automation equipment and pneumatic cylinders right along with import and export.

WINMAN and **FREEWAY** brands are created besides attaching importance to branding, marketing and enhancing sales network. Concordantly, Hidtek has extended its domestic and foreign sales network day by day.

Hidtek is determined to keep up with the future and ever-growing technology as it always has been by means of the R&D center established on production.

General usage areas of the production and sales materials are:

- Automotive industry
- Machine industry
- Packaging machines
- PVC profile processing machines
- Hoisting machinery (elevator, lift)
- Sheet metal working machines
- Hydraulic presses
- Heavy construction equipment
- Agricultural machines
- Custom-made machines and equipment

Our company reserves the right to modify photos, measurements and other values that were published in the catalog.

W WINMAN®

Türk Markası



WAC serisi silindirler

ISO 15552 normunda

32 - 125 çaplarında

Standart manyetik ve yastıklımalı

Opsiyon olarak paslanmaz milli

Viton keçeli

Tandem

Pozisyoner

Çift milli

Yağsız çalışabilme



paslanmaz



W WINMAN®

Türk Markası



WSSC serisi silindirler

ISO 6432 normunda

4-40 çaplarında

Standart manyetik ve yastıklı malı

Paslanmaz boru ve paslanmaz milli

Yağsız çalışabilme özelliđi



paslanmaz



W WINMAN®

Türk Markası



WSAC serisi silindirlere

20 - 100 çaplarında

*Kompakt yapısı ile dar yerler için
uygun çözüm*

Standart manyetik

Opsiyon olarak paslanmaz milli

Viton keçeli

Yağsız çalışabilme özelliği



W WINMAN®

Türk Markası



WACC serisi silindirler

ISO 21287 normunda

20 - 100 çaplarında

Kompakt yapısı ile dar yerler için
uygun çözüm

Standart manyetik

Opsiyon olarak paslanmaz milli

Viton keçeli

Yağsız çalışabilme özelliği

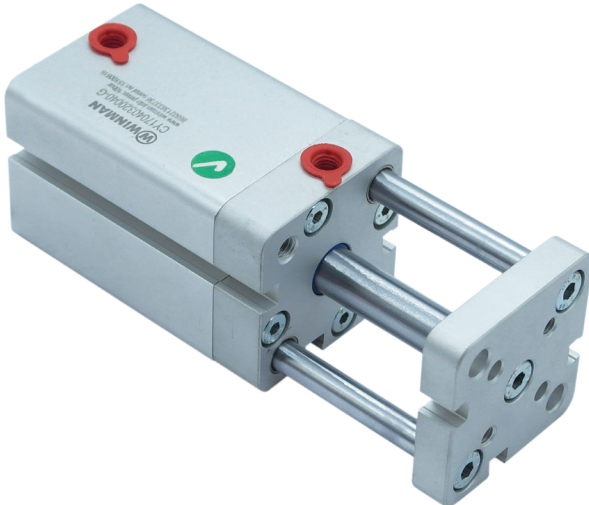

W WINMAN®

Türk Markası



WGC serisi silindirler

16 - 63 çaplarında

Rulmanlı ve burçlu

Standart manyetik

Opsiyon olarak paslanmaz milli

Viton keçeli

Yanal yüklerle karşı dayanım

Yağsız çalışabilme özelliği

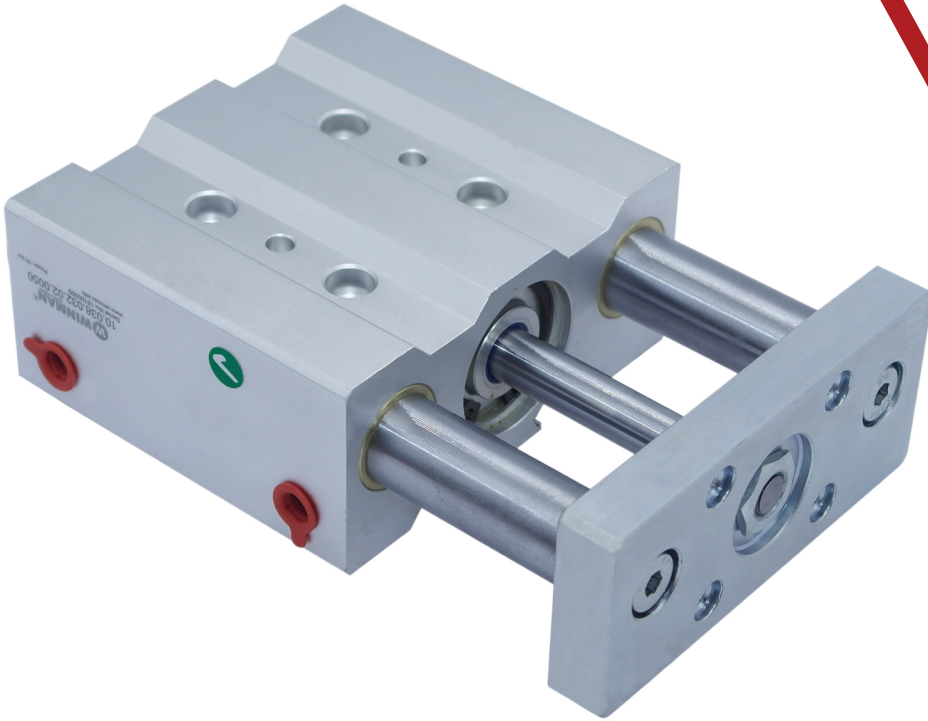

W WINMAN®

Türk Markası

Stopper Silindir

Ø20, 25, 32, 40, 50, 63 çaplarında

Manyetik

Yağsız çalışma özelliği

Tek etkili ve çift etkili



W WINMAN®

Türk Markası



Sektöre Özel Silindirler

- Teleskobik
- Pozisyoner
- Strok ayarlı
- Yataklamalı

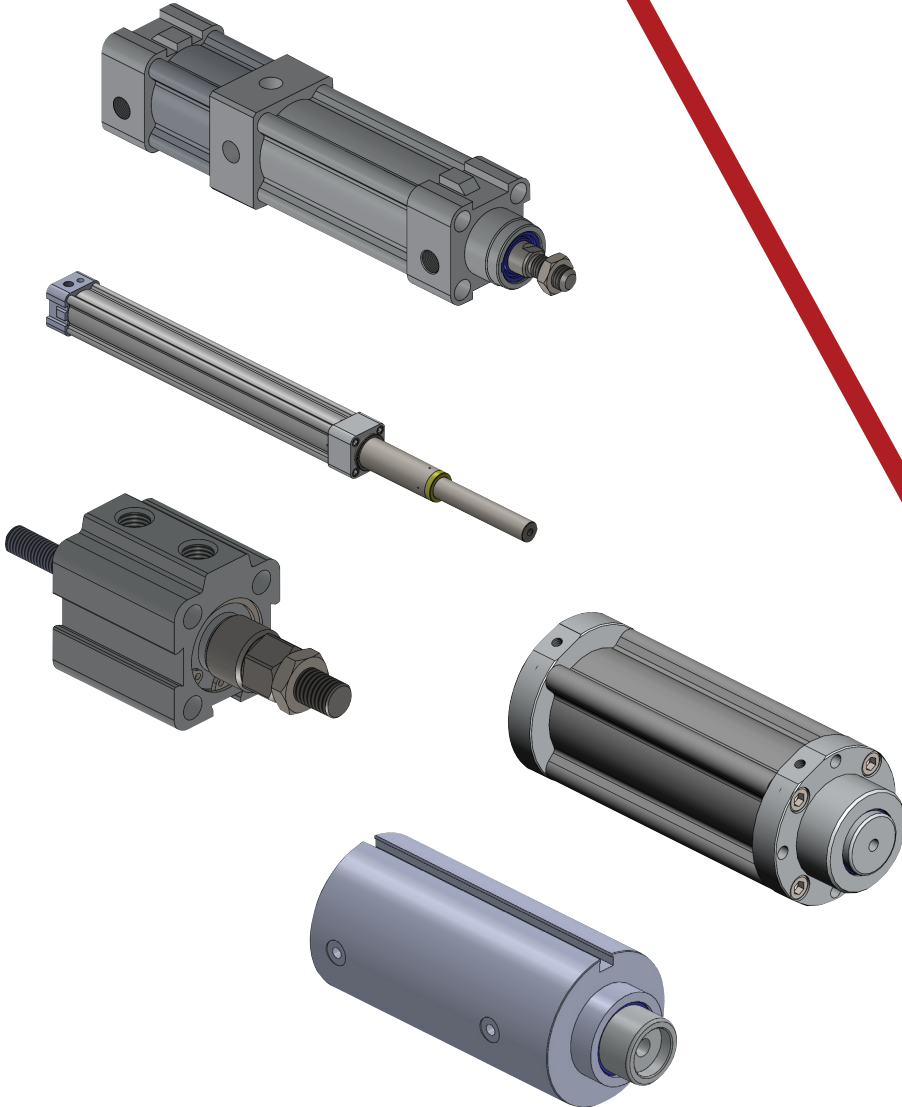

W WINMAN®

Türk Markası

Döner klempler ve dönmez milli silindirlere

Çeşitli çaplarda ve istenilen kurslarda

Yağsız çalışmaya uygun

Uzun ömürlü

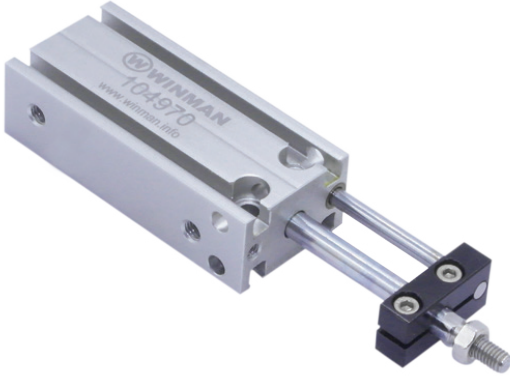
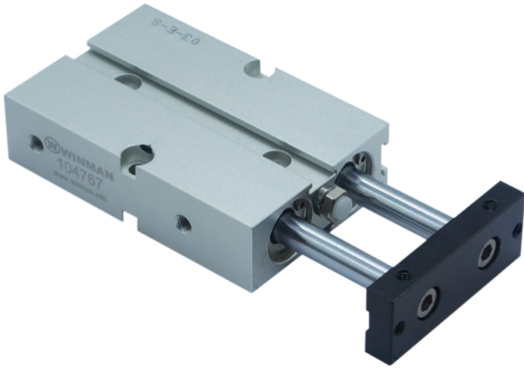

W WINMAN®

Türk Markası



1/8 ve 1/4 ölçülerinde

Multi konnektörlü

Tek bobin - Çift bobin

5/3 uygulamalar

22 bobin çalıştırabilme kapasitesi

Yağsız çalışabilme özelliği

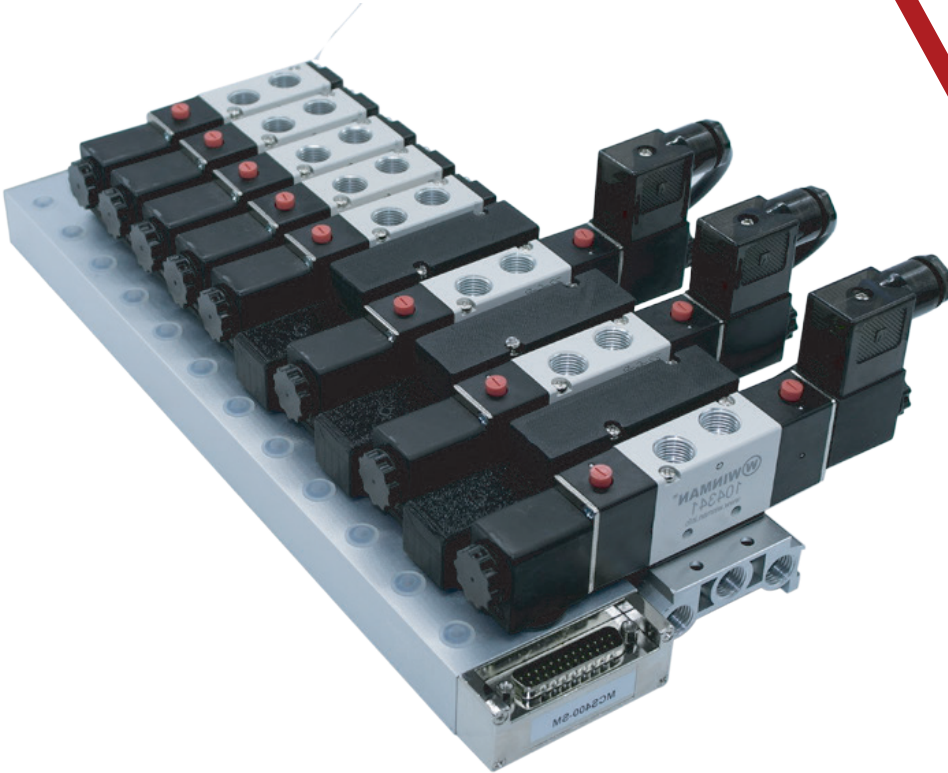

W WINMAN®

Türk Markası

GF serisi hava hazırlayıcılar

1/4" - 1" ölçülerinde

5μ - 40μ filtreleme seçenekleri

0-10 bar

Otomatik tahliye özelliği



W WINMAN®

Türk Markası



W serisi oransal regülâtör

0 - 10 V veya 4-20 mA

1/8 - 1/2 ölçülerinde

Ekstra hızlı cevap veren

P25V dijital basınç ve vakum şalteri

1bar + 10 bar aralığında

1/8 ölçüsünde

Dijital

İki çıkış verebilen

W WINMAN®

Türk Markası

Pnömatik aktüatörler

1/2" - 4" ölçülerinde

2 parçalı ve 3 parçalı vana seçenekleri

2 yollu ve 3 yollu vana seçenekleri

304 - 316 kalite paslanmaz

Limit switch box montajına uygun



W WINMAN[®]
Türk Markası



Solvent Püskürtme

Dahili tazyik valfi

Kompakt ve entegre yapı

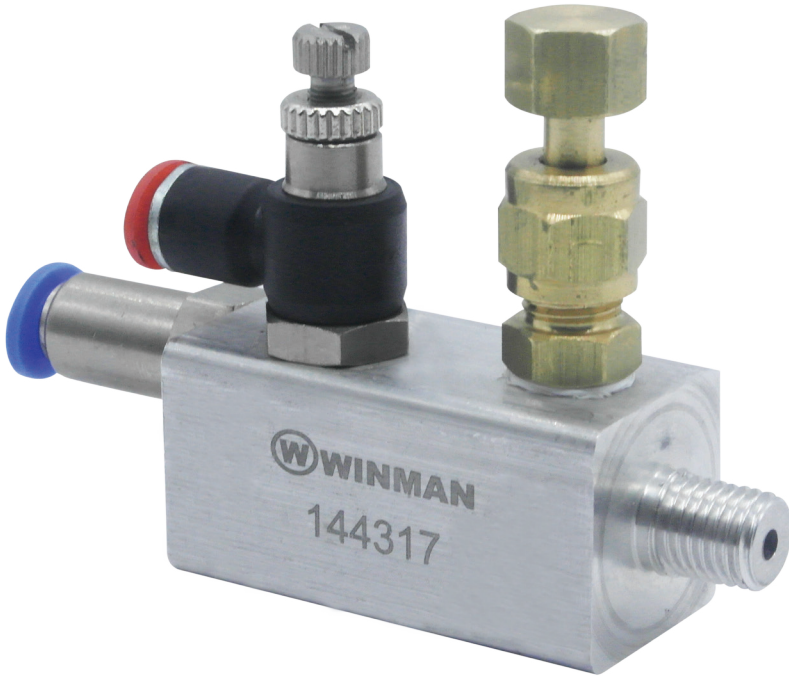

W WINMAN®

Türk Markası

Pnömatik rekorlar

ø3 - ø16 hortum ölçülerinde

M3 - 1/2" dış ölçülerinde

*Plastik, metal, paslanmaz ve
sıkmalı seçenekler*

Düz ve dirsekli perde geçiş nipelleri

2/2, 3/2 aç kapa vana modelleri



W WINMAN®
Türk Markası

PU hortum

ø3 - ø16 ölçülerinde

9 farklı renk seçeneğiyle

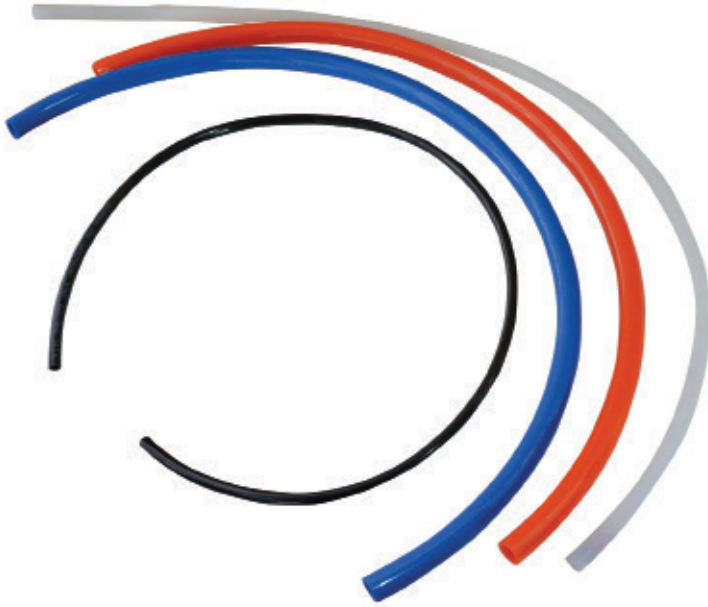

W WINMAN[®] Türk Markası

Shock Absorber

Sabit ve ayarlanabilir tiplerde

M8 - M36 ölçü aralıklarında



W WINMAN® Türk Markası

Lineer araba ve raylar

15-45 ölçülerinde

Geniş-dar ve uzun araba tipleri

Üstten ve alttan ray montaj imkanı

Arabalarda 3 odalı yağ haznesi

Kompozit sıyrıcı

Uzun ömürlü

Yüksek taşıma kapasitesi



W WINMAN[®]
Türk Markası

Vidalı mil ve somunları

ø16 - ø100 ölçülerinde

5 - 10 hatvelerinde

Uzun ömürlü



W WINMAN[®] Türk Markası

İndüksiyonlu mil ve kayar rulmanlar

Çeşitli çap ve boylarda



W WINMAN®

Türk Markası

Lineer aktüatör

ISO 15552 ye uygun

32, 40, 63, 80 ve 100 ölçülerinde

Vidalı milli ve speedy milli

Servo , step ve DC motora uygun



W WINMAN®

Türk Markası

Lineer modüller

80X80, 145X65, 45X90 profil ölçülerinde

Vidalı milli ve triger kayışlı

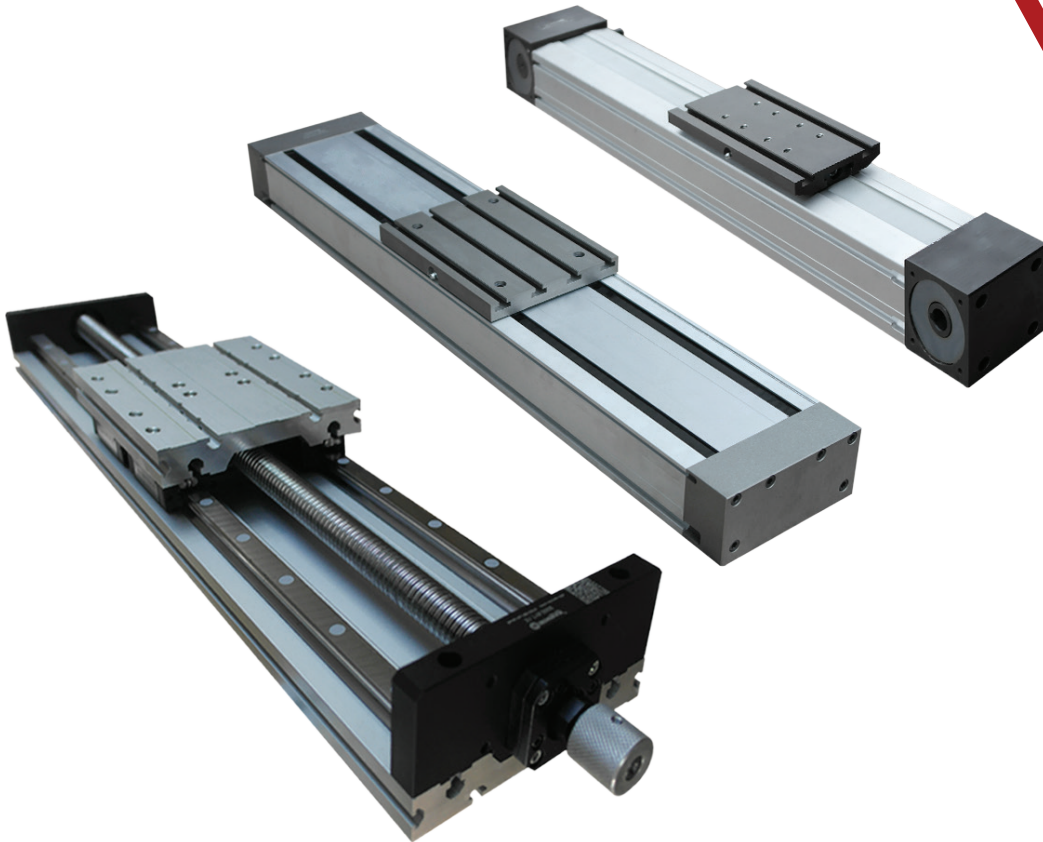

W WINMAN®

Türk Markası

Entegre Tip Servo Motor

Servo Motor Kaplinleri





Turtle Vakum Üreteci

Entegre tip vakum üreteci

Üç odalı vakum kartuşu

*Dalgalandan ve düşük basınçlı hava
basıncına rağmen yüksek
vakum seviyesi*

Bıraktırma fonksiyonu

*Dijital veya mekanik
vakum anahtarı*

Hava tasarruf kitli





Mini vakum üretici ve vakum filtresi

Üç odalı vakum üretici

Hava sarfiyatı düşük

Uzun ömürlü



W WINMAN®

Türk Markası

Hidrolik Güç Ünitesi

Projeye özel üretim

Çeşitli çap ve stroklarda hidrolik silindirler





HİD-TEK LTD. ŞTİ.

Üçevler Mah. Ünalp Sok. No: 1/A
Nilüfer / BURSA / TÜRKİYE
Tel: 0.224.443 16 20
Fax : 0.224.443 16 37

İkitelli / İSTANBUL
Tel : 0.212.549 98 36
Fax :0.212 549 98 39

İmes / İSTANBUL
Tel : 0.216.365 70 71
Fax :0.216.365 70 72

Bornova / İZMİR
Tel : 0.232.433 54 44
Fax :0.232.433 00 31

Karatay / KONYA
Tel : 0.332.345 03 00
Fax :0.332.345 03 24

İzmit / KOCAELİ
Tel : 0.262.335 60 10
Fax :0.262.335 60 11

Yenimahalle/ ANKARA
Tel : 0.312.394 83 64
Fax :0.312.394 83 66

Plovdiv / BULGARİSTAN
Tel : +359 32 941 963
Fax : +359 32 941 970