

## Compact slide cylinder (Roller bearing) WLS Serisi

Series name	Acting type	Bore size	Collocation of sensor switch DS1-H
	Double acting	6	●
		8	●
		12	●
		16	●
		20	●
		25	●

### Instalation and application

1. Dirty substances in the pipe must be eliminated before cylinder is connected with pipeline to prevent the entrance of impurities into the cylinder.
2. The medium used by cylinder should be filtered to 40μ m or below.
3. Anti - freezing measure shall be adopted under low temperature enviroment to prevent moisture freezing.
4. If the cylinder is dismantled and stored for a long time, pay attention to conduct anti - rust treatment to the surface.  
Anti - dust caps shall be added in air inlet and outlet ports.

### Criteria for selection: Cylinder thrust

Bore size (mm)	Rod size (mm)	Acting type		Pressure area (mm <sup>2</sup> )	Operating pressure (MPa)					
					0.2	0.3	0.4	0.5	0.6	0.7
6	3	Double acting	Push side	42	8	13	17	21	25	29
			Pull side	57	11	17	23	29	34	40
8	4	Double acting	Push side	75	15	23	30	38	45	53
			Pull side	101	20	30	40	51	61	71
12	6	Double acting	Push side	170	34	51	68	85	102	119
			Pull side	226	45	68	90	113	136	158
16	8	Double acting	Push side	302	60	91	121	151	181	211
			Pull side	402	80	121	161	201	241	281
20	10	Double acting	Push side	471	94	141	188	236	283	330
			Pull side	628	126	188	251	314	377	440
25	12	Double acting	Push side	756	151	227	302	378	454	529
			Pull side	982	186	295	393	491	589	687

### Specification

Bore size(mm)	6	8	12	16	20	25
Acting type	Double acting					
Fluid	Air(to be filtered by 40 μ m filter element)					
Operating pressure	0.15~0.7MPa(22~100psi)(1.5~7.0bar)					
Proof pressure	1.05MPa(150psi)(10.5bar)					
Temperature °C	-20~70					
Speed range mm/s	50~500					
Stroke tolerance	+1.0 0					
Cushion type	Bumper(Both ends), Shock absorber					
Sensor switches ①	DS1-H□N、DS1-H□P					
Port size	M5 × 0.8					1/8"

① Sensor switch should be ordered additionally, please refer to P419-442 for detail of sensor switch.



**Stroke**

Bore size (mm)	Standard stroke (mm)	Max. stroke (mm)
6	10 20 30 40 50	50
8	10 20 30 40 50 75	75
12	10 20 30 40 50 75 100	100
16	10 20 30 40 50 75 100 125	125
20	10 20 30 40 50 75 100 125 150	150
25	10 20 30 40 50 75 100 125 150	150

Note) Consult us for non-standard stroke.

**Symbol**

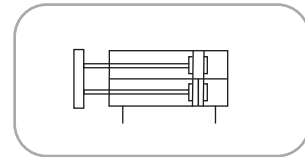

**Ordering Code**

**HLS 20 × 30 S AS** □

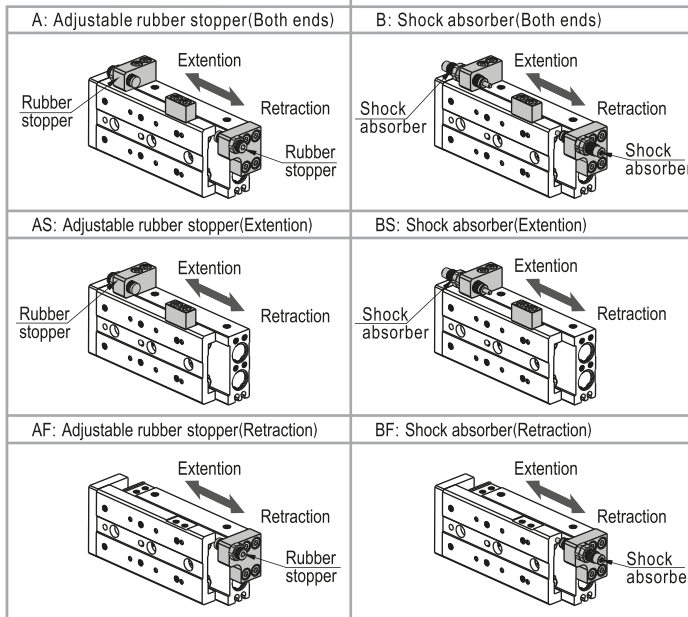
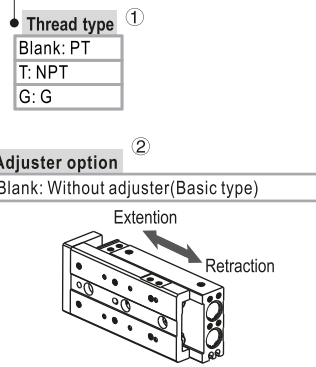
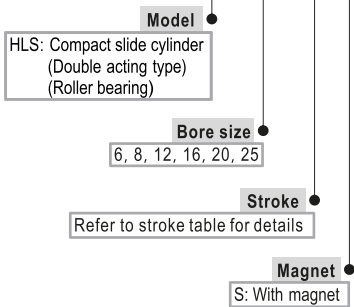

① When the thread is standard, the code is blank.  
 ② B type, BS type, BF type are unavailable for bore size of  $\Phi 6$ .

**Product feature**

1. Roller bearing incorporating the cylinder, it achieves high precision, high rigidity, high load, excellent linearity and non-rotate tolerance. So it can be used in precision assemblage condition.
2. Pin holes for positioning improved repeatability of work mounting
3. Floating jointer design  
Piston rod needn't endure additional torque
4. Dual rod, doubles the output thrust
5. Pin holes for positioning  
Improved repeatability of body mounting
6. Body mounting tap Mounting from 3 direction available

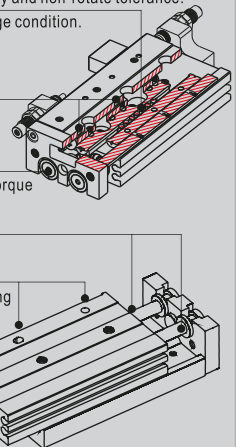

## Model Selection Method

Please select compact cylinder's type according to following procedure, and cross reference with data sheets.

### 1) Operating conditions(According to mounting position and work form)

1. Model used(Bore size, Stroke)
2. Type of cushion(Bumper, Shock absorber)
3. Mounting position of work(Top, front)
4. Mounting direction(Axial, Vertical)
5. Average speed Va(mm/s)
6. Applied load W(N) **Fig. 1**
7. Overhang L1, L2, L3(mm)

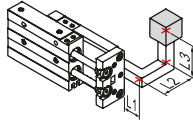

Explain: L1 is the distance of load's center beyond the end plank's plane. If load's center is not beyond the end plank's plane, L1 is negative.

**Fig. 1:** Applied load

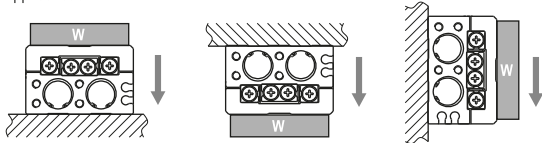

### 2) Kinetic energy check

#### Steps

1. Calculate kinetic energy of load E(J)

$$E = \frac{1}{2} \times \frac{W}{g} \times \left( \frac{1.4 \times V_a}{1000} \right)^2$$

2. Calculate allowable kinetic energy Ea(J)

$$E_a = K \times E_{max}$$

K: Mounting work coefficient (**Fig 2**)

E<sub>max</sub>: Maximum allowable kinetic energy (**Table 1**)

3. Check that kinetic energy of load doesn't exceed allowable kinetic energy:

$$E \leq E_a$$

### 3) Load check

#### Steps

1. Calculate allowable applied load Wa (N)

$$W_a = K \times \beta \times W_{max}$$

K: Mounting work coefficient (**Fig 2**)

W<sub>max</sub>: Maximum allowable applied load (**Table 1**)

β: Applied load coefficient (**Fig 3**)

2. Check that load(W) doesn't exceed allowable applied load(Wa):

$$W \leq W_a$$

**Fig 2:** Mounting work coefficient (K)

Top

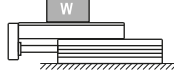

Mounting work coefficient K=1

Front

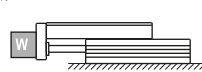

Mounting work coefficient K=0.6

**Fig 3:** Applied load coefficient (β)

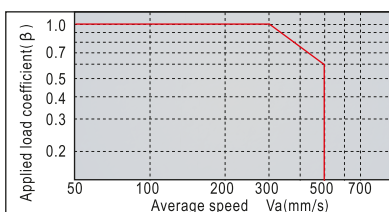

### 4) Moment check

#### Steps

#### Horizontal

1. Calculate actual moment: Mp, Mpo, My, Myo, Mr, Mro (Nm)

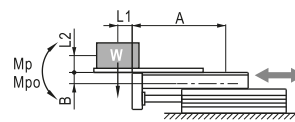

Dynamic moment:  
 $M_p = W \times (L_1 + A) / 1000$

Static moment:  
 $M_{po} = \frac{W \times (L_1 + A)}{1000} + \frac{W \times a \times (L_2 + B)}{1000 \times g}$

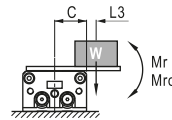

Dynamic moment:  
 $M_r = W \times (C + L_3) / 1000$

Static moment:  
 $M_{ro} = (W \times a \times (C + L_3)) / 1000g$

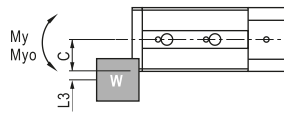

Dynamic moment:  
 $M_y = 0$

Static moment:  
 $M_{yo} = (W \times a \times (C + L_3)) / 1000g$

2. Check

Dynamic moment:  $\frac{M_p}{M_{p_{max}}} + \frac{M_y}{M_{y_{max}}} + \frac{M_r}{M_{r_{max}}} \leq 1$

Static moment:  $\frac{M_{po}}{M_{po_{max}}} + \frac{M_{yo}}{M_{yo_{max}}} + \frac{M_{ro}}{M_{ro_{max}}} \leq 1$

#### Vertical

1. Calculate actual moment: Mp, Mpo, My, Myo (Nm)

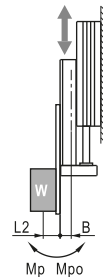

Dynamic moment:  
 $M_p = W \times (L_2 + B) / 1000$

Static moment:  
 $M_{po} = \frac{W \times (L_2 + B)}{1000} + \frac{W \times a \times (L_2 + B)}{1000 \times g}$

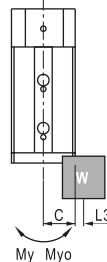

Dynamic moment:  
 $M_y = W \times (C + L_3) / 1000$

Static moment:  
 $M_{yo} = \frac{W \times a \times (C + L_3)}{1000g} + \frac{W \times (C + L_3)}{1000}$

2. Check

Dynamic moment:  $\frac{M_p}{M_{p_{max}}} + \frac{M_y}{M_{y_{max}}} \leq 1$

Static moment:  $\frac{M_{po}}{M_{po_{max}}} + \frac{M_{yo}}{M_{yo_{max}}} \leq 1$

Explain:

L1, L2, L3: The distance of load center to mount plane (Determined by actuality).

A, B, C: Correction value for center position distance of moment (Refer to table 2).

M<sub>p\_max</sub>, M<sub>y\_max</sub>, M<sub>r\_max</sub>, M<sub>po\_max</sub>, M<sub>yo\_max</sub>, M<sub>ro\_max</sub>: Maximum allowable moment (Refer to table 2).

g: Acceleration of gravity (g=9.81m/s<sup>2</sup>).

a: Acceleration of inertia

(Bumper: a=1600 × (Va/1000)<sup>2</sup>, Shock absorber: a=400 × (Va/1000)<sup>2</sup>)

W: Load weight (Determined by actuality).

**WLS Series**

**Note:** Symbol and unit

Symbol	Item	Unit
A, B, C	Correction value for center position distance of moment	mm
a	Acceleration of inertia	-
E	Kinetic energy	J
Ea	Allowable kinetic energy	J
E <sub>max</sub>	Maximum allowable kinetic energy	J
g	Acceleration of gravity g=9.81	m/s <sup>2</sup>
K	Mounting work coefficient	-
L1, L2, L3	Overhang	mm
Mp, My, Mr	Dynamic moment(Pitch、Yaw、Roll)	Nm
Mp <sub>max</sub> , My <sub>max</sub> , Mr <sub>max</sub>	Maximum allowable dynamic moment(Pitch、Yaw、Roll)	Nm
Mpo, Myo, Mro	Static moment(Pitch、Yaw、Roll)	Nm
Mpo <sub>max</sub> , Myo <sub>max</sub> , Mro <sub>max</sub>	Maximum allowable static moment(Pitch、Yaw、Roll)	Nm
Va	Average speed	mm/s
W	Applied load	N
W <sub>max</sub>	Maximum allowable applied load	N
β	Applied load coefficient	-

**Table 1:** Maximum allowable kinetic energy(E<sub>max</sub>), Maximum allowable applied load(W<sub>max</sub>)

Model	Max. allowable kinetic energy E <sub>max</sub> (J)			Max. allowable
	Basic type	Robber stopper type	Shock absorber type	
WLS6	0.01	0.01	-	5
WLS8	0.024	0.024	0.048	10
WLS12	0.05	0.05	0.1	20
WLS16	0.1	0.1	0.2	35
WLS20	0.13	0.13	0.26	55
WLS25	0.22	0.22	0.44	70

**Table 2:** Maximum allowable moment(Nm), Correction value for center position distance of moment(mm)

Bore size	Stroke	Static moment			Dynamic moment			Correction value		
		Mp <sub>max</sub>	My <sub>max</sub>	Mr <sub>max</sub>	Mp <sub>max</sub>	My <sub>max</sub>	Mr <sub>max</sub>	A	B	C
6	10	3.3	3.8	2.6	0.7	0.7	0.6	27	7.3	16
	20	3.3	3.8	2.6	0.7	0.8	0.6	42		
	30	3.3	3.8	2.6	0.7	0.8	0.6	52		
	40	7.2	7.9	3.6	1.3	1.3	0.6	72		
	50	12.4	12.7	4.7	1.8	1.8	0.6	87		
8	10	10.1	9.1	8.8	2.5	2.5	2.0	32	8.5	20
	20	10.1	9.1	8.8	2.6	2.6	2.0	42		
	30	10.1	9.1	8.8	2.8	2.8	2.0	57		
	40	12.4	10.8	10.1	3.4	3.4	2.3	72		
	50	23.6	24.8	13.9	4.4	4.4	2.1	92		
12	10	33.0	34.3	30.9	7.3	7.3	5.8	48	10	25
	20	33.0	34.3	30.9	7.6	7.6	5.8	58		
	30	33.0	34.3	30.9	7.8	7.8	5.8	68		
	40	33.0	34.3	30.9	8.0	8.0	5.8	78		
	50	53.4	49.6	39.7	9.8	9.8	5.8	88		
16	10	33.0	34.3	30.9	8.8	8.8	7.6	43	11	30
	20	33.0	34.3	30.9	9.2	9.2	7.6	53		
	30	33.0	34.3	30.9	9.5	9.5	7.6	63		
	40	33.0	34.3	30.9	10.0	10.0	7.6	78		
	50	53.4	49.6	39.7	12.2	12.2	7.6	93		
20	10	60.1	50.5	72.8	14.5	14.5	15.2	47	16.5	35
	20	60.1	50.5	72.8	15.2	15.2	15.2	57		
	30	60.1	50.5	72.8	15.7	15.7	15.2	67		
	40	60.1	50.5	72.8	16.3	16.3	15.2	82		
	50	60.1	50.5	72.8	16.6	16.6	15.2	92		
25	10	60.1	50.5	72.8	17.0	17.0	17.6	52	20.3	42
	20	60.1	50.5	72.8	17.4	17.4	17.6	62		
	30	60.1	50.5	72.8	17.4	17.4	17.6	72		
	40	60.1	50.5	72.8	17.8	17.8	17.6	82		
	50	60.1	50.5	72.8	18.2	18.2	17.6	96		
25	75	169.3	154.3	114.4	45.2	45.2	25.3	141	20.3	42
	100	169.3	154.3	114.4	46.2	46.2	25.3	165		
	125	169.3	154.3	114.4	48.0	48.0	25.3	210		
	150	267.5	286.6	145.6	65.0	65.0	28.3	254		
	150	267.5	286.6	145.6	65.0	65.0	28.3	254		

**Inner structure**

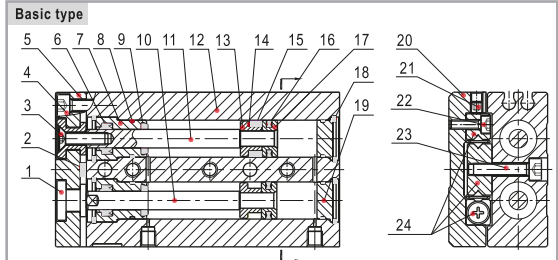

NO.	Item	Material	NO.	Item	Material
1	Floating jointer	Carbon steel	13	Magnet holder	Brass
2	Bumper	TPU	14	Magnet washer	NBR
3	Screw	Carbon steel	15	Magnet	Sintered metal (Neodymium-iron-boron)
4	Screw	Carbon steel	16	Piston seal	NBR
5	Fixing plate	Aluminum alloy	17	Piston	Brass
6	Rod seal	NBR	18	C clip	Spring steel
7	Front cover	Aluminum alloy	19	Back cover	Aluminum alloy
8	O-ring	NBR	20	Slide table	Aluminum alloy
9	Bumper	TPU	21	Nut	Carbon steel
10	Piston rod A	Carbon steel	22	Screw	Carbon steel
11	Piston rod B	Stainless steel	23	Screw	Carbon steel
12	Body	Aluminum alloy	24	Slide guide combination	subassembly



## Installation and application

### 1. How to mount cylinder:

#### 1.1) Cylinder can to be mounted from 3 directions

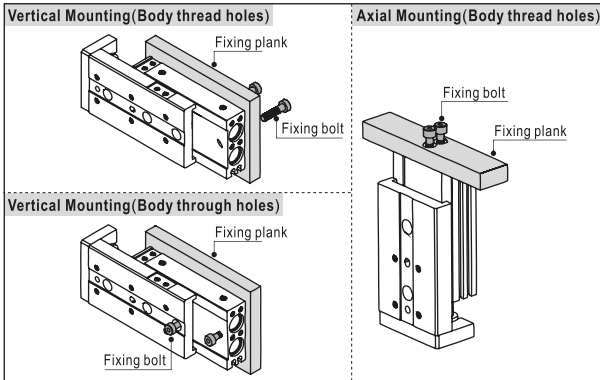

1.2) When mounting a compact slide cylinder, screws of appropriate length should be used and tightened properly within the maximum tightening torque. If screws are tightened beyond designed limits, malfunction may occur. If they are tightened insufficiently, it may result in sliding or falling off from its position.

**Vertical Mounting (Body thread holes)**

Model	Bolt used	Max. tightening torque (Nm)	Max. screw-in depth (mm)
WLS6	M4 × 0.7	2.1	8.0
WLS8	M4 × 0.7	2.1	8.0
WLS12	M5 × 0.8	4.4	10.0
WLS16	M6 × 1.0	4.4	10.0
WLS20	M6 × 1.0	7.4	12.0
WLS25	M8 × 1.25	18.0	16.0

**Vertical Mounting (Body through holes)**

Model	Bolt used	Max. tightening torque (Nm)	Body depth L (mm)
WLS6	M3 × 0.5	1.2	11.0
WLS8	M3 × 0.5	1.2	12.5
WLS12	M4 × 0.7	2.8	18.0
WLS16	M5 × 0.8	5.7	25.0
WLS20	M5 × 0.8	5.7	28.0
WLS25	M6 × 1.0	10.0	36.2

**Axial Mounting (Body thread holes)**

Model	Bolt used	Max. tightening torque (Nm)	Max. screw-in depth (mm)
WLS6	M2.5 × 0.45	0.5	3.5
WLS8	M3 × 0.5	0.9	4.0
WLS12	M4 × 0.7	2.1	6.0
WLS16	M5 × 0.8	4.4	7.0
WLS20	M5 × 0.8	4.4	8.0
WLS25	M6 × 1.0	7.4	10.0

### 2. Work Piece Mounting:

#### 2.1) Work pieces can be mounted on 2 surfaces of the compact slide.

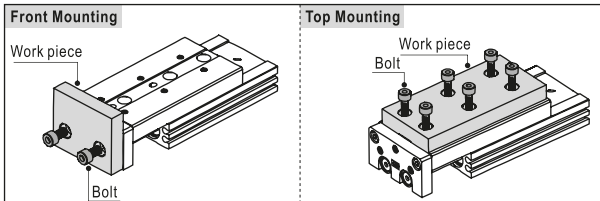

2.2) When mounting a work piece, tighten the bolts properly at a torque value within the limiting range. Use bolts at least 0.5mm shorter than maximum thread depth to prevent bolts from contacting the guide block. If the bolts are too long, they hit the guide block and cause damage.

### Front Mounting

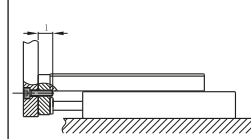

Model	Bolt used	Max. tightening torque (Nm)	Max. screw-in depth (mm)
WLS6	M3 × 0.4	0.9	5.0
WLS8	M4 × 0.7	2.1	6.0
WLS12	M5 × 0.8	4.4	8.0
WLS16	M6 × 1.0	7.4	10.0
WLS20	M6 × 1.0	7.4	13.0
WLS25	M8 × 1.25	18.0	15.0

### Top Mounting

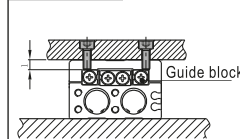

Model	Bolt used	Max. tightening torque (Nm)	Max. screw-in depth (mm)
WLS6	M3 × 0.5	0.9	4.0
WLS8	M3 × 0.5	0.9	5.0
WLS12	M4 × 0.7	2.1	5.5
WLS16	M5 × 0.8	4.4	6.0
WLS20	M5 × 0.8	4.4	10.0
WLS25	M6 × 1.0	7.4	13.0

2.3) Since the table is supported by the linear guide, take care not to apply strong impact or large moment to the guide section.

2.4) Hold the slide when fastening work pieces to it with bolts. If the body is held while tightening bolts, excessive moment may damage guide section.

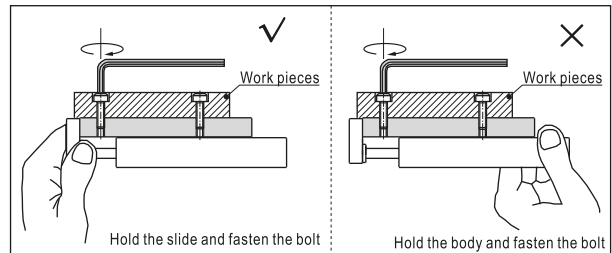

### 3. About shock absorber:

3.1) Shock absorbers are expendable parts. Promptly replace them when energy absorbing capacity decreases.

3.2) Never turn or adjust the screws on bottom of the shock absorber body. The screws are not for adjusting. Otherwise would cause oil leakage.

3.3) Follow the table for tightening torque of shock absorber to lock nuts.

**Shock absorber lock nut**

Model	Shock absorber	Tightening torque
WLS6	Without shock absorber	
WLS8	ACA0806-1N	1.67(Nm)
WLS12	ACA0806-1N	1.67(Nm)
WLS16	ACA1007-1N	3.14(Nm)
WLS20	ACA1210-1N	3.14(Nm)
WLS25	ACA1412-1N	10.8(Nm)

The screws are not adjustable otherwise would cause oil leakage.

### 4. How to mount sensor switch:

4.1) HLS Series are all with magnet. The matching sensor switches are DS1-H, DS1-HL series. Please refer to page 419-442 for details.

4.2) Maintain a minimum spacing of at least 3mm if two compact cylinders are used side by side in order to avoid malfunction.

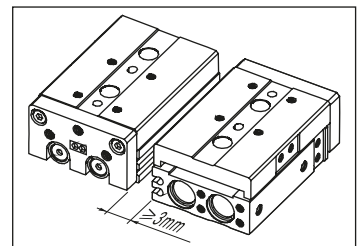

5. Make sure to connect the compact cylinder to speed controller at the meter-out side, and the speed of compact cylinder must be below 500mm/s.

6. Don't apply a load beyond the range of the operation limits. Different load or torque will cause different deflection to table, please see below for details.

**WLS Series**

6.1) Table deflection due to pitch moment:  
Table deflection (arrow) when a load acts upon the section marked with the arrow at the full stroke of the compact slide.

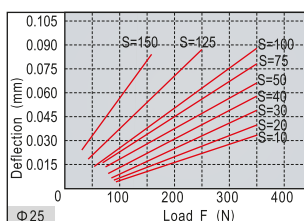
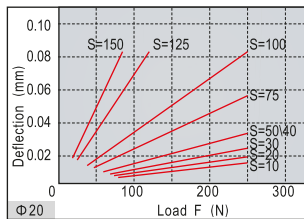
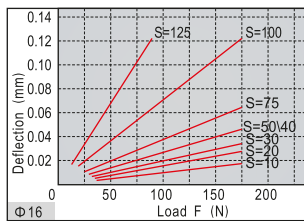
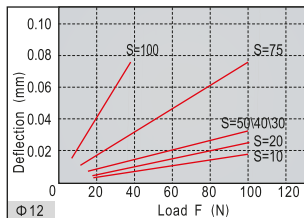
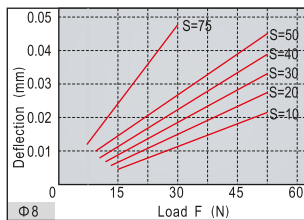
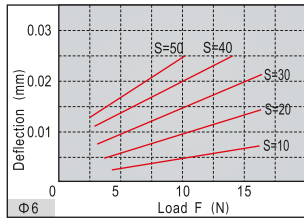

6.2) Table deflection due to yaw moment:

Table deflection (arrow) when a load acts upon the section marked with the arrow at the full stroke of the compact slide.

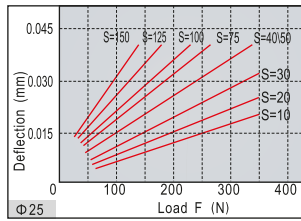
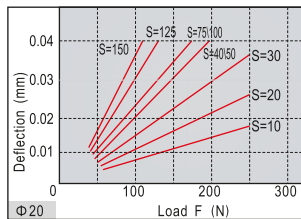
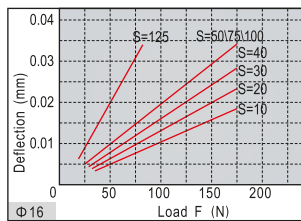
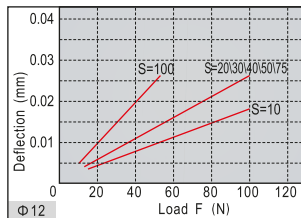
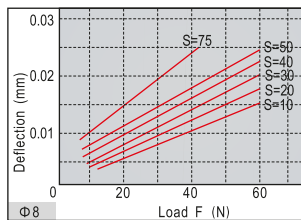
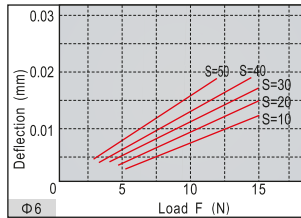
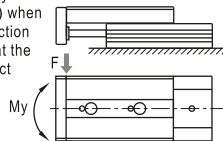

6.3) Table deflection due to roll moment:

Table deflect at A when a load acts upon section F at the full stroke of the compact slide.

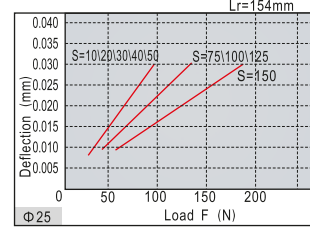
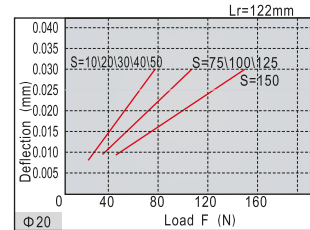
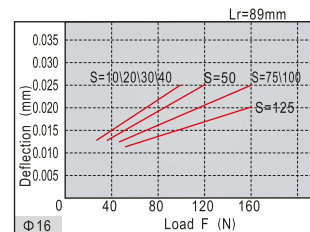
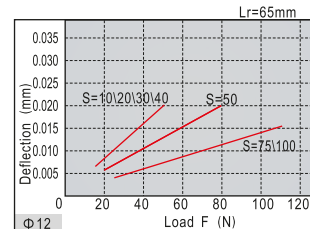
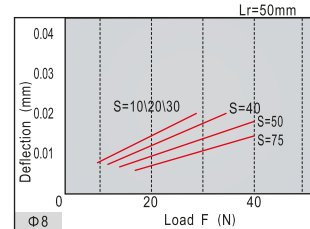
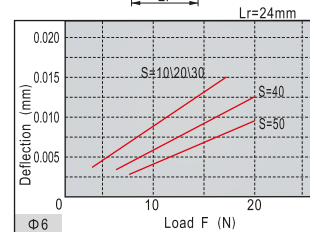
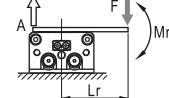

**Dimensions**

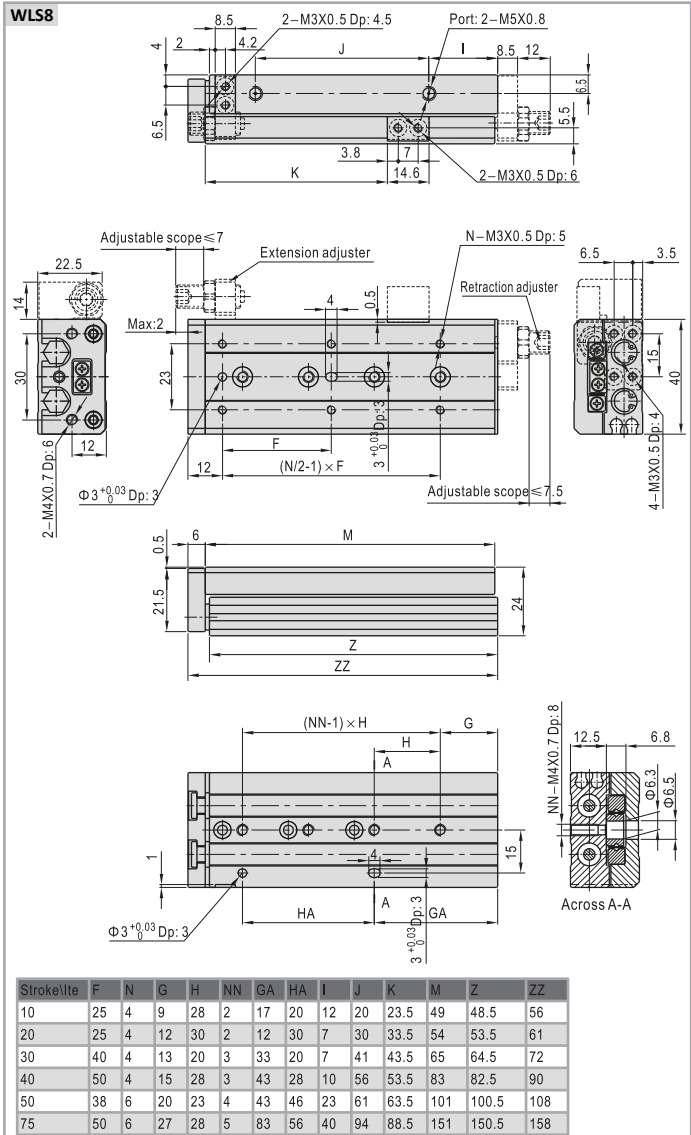
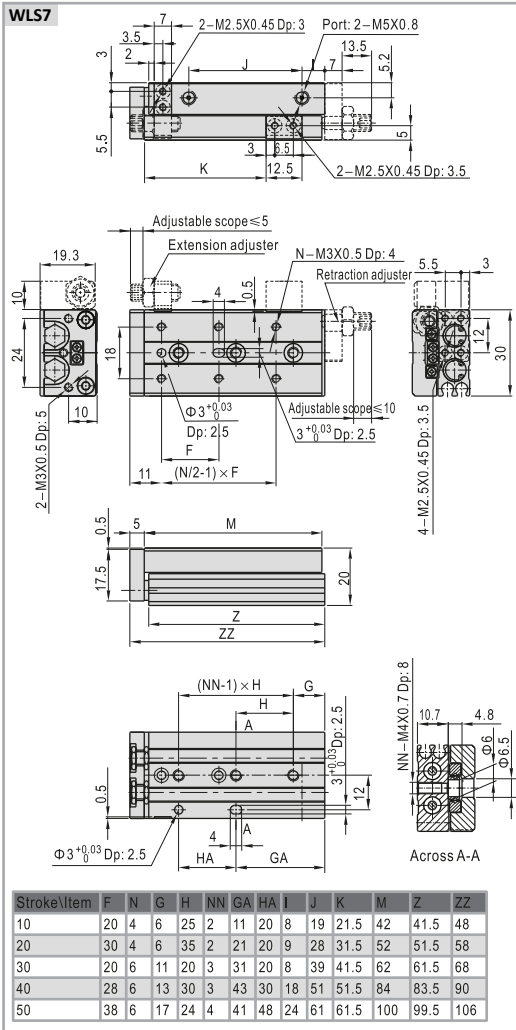

**WLS8(With shock absorber)**

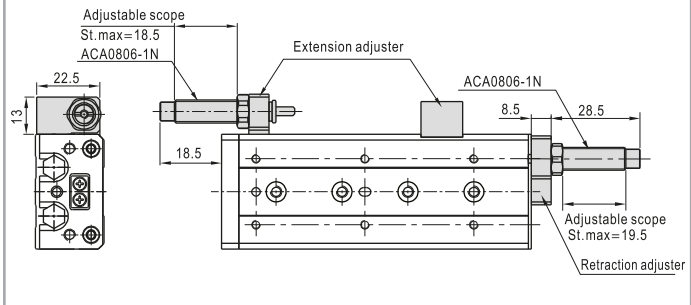

**WLS Series**

**WLS12**

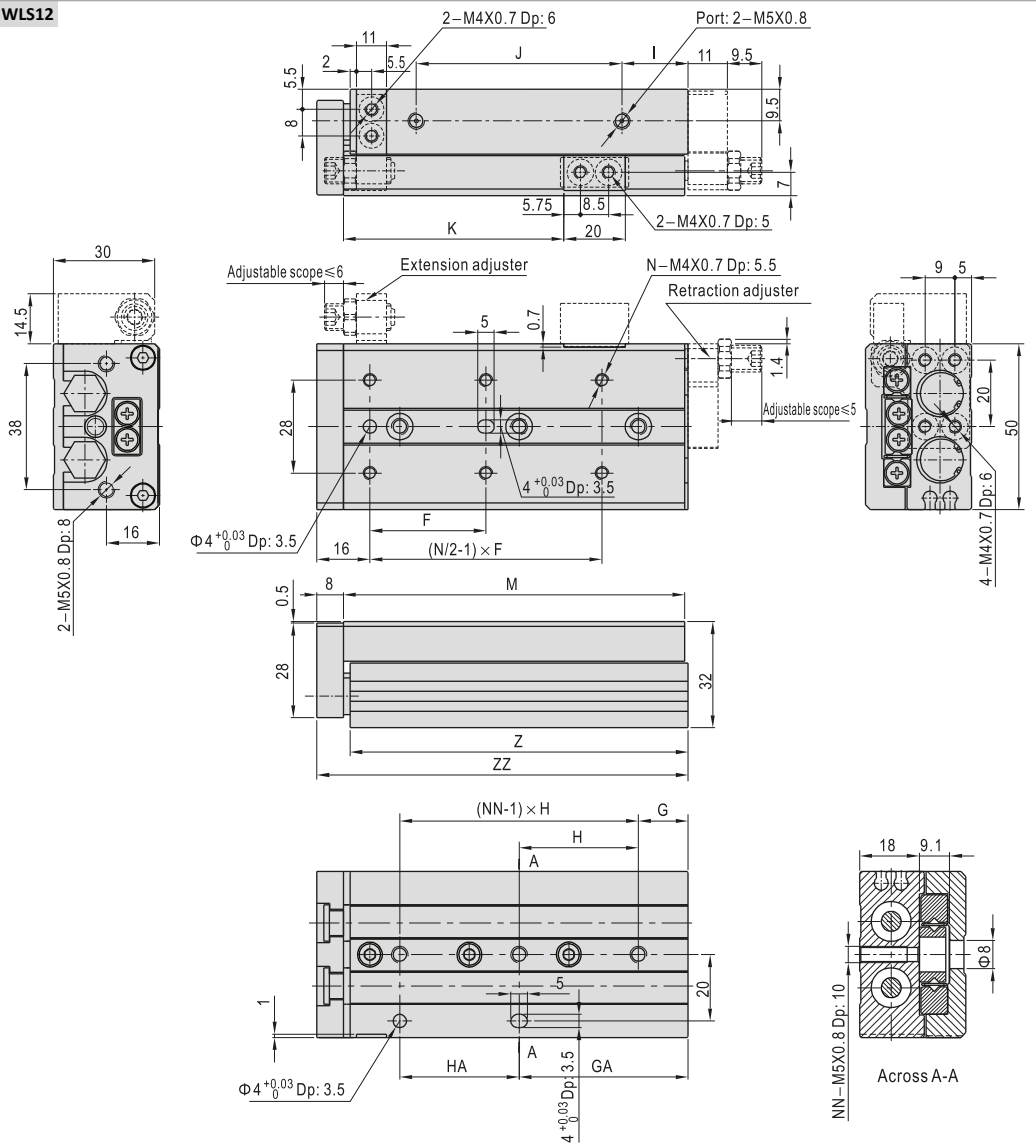

Stroke\Item	F	N	G	H	NN	GA	HA	I	J	K	M	Z	ZZ
10	35	4	15	40	2	15	40	10	39.5	25	71	70	80
20	35	4	15	40	2	15	40	10	39.5	35	71	70	80
30	35	4	15	40	2	15	40	10	39.5	45	71	70	80
40	50	4	17	25	3	42	25	10	51.5	55	83	82	92
50	35	6	15	36	3	51	36	20	61.5	65	103	102	112
75	55	6	25	36	4	61	72	40	87.5	90	149	148	158
100	65	6	35	38	5	111	76	50	131.5	115	203	202	212

**WLS12(With shock absorber)**

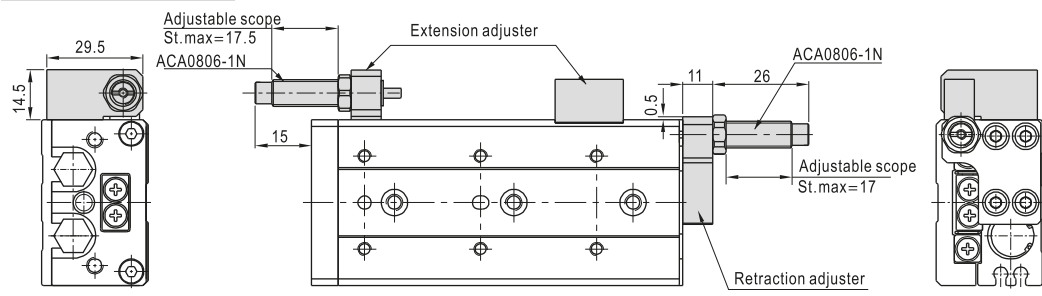

**WLS Series**

**WLS16**

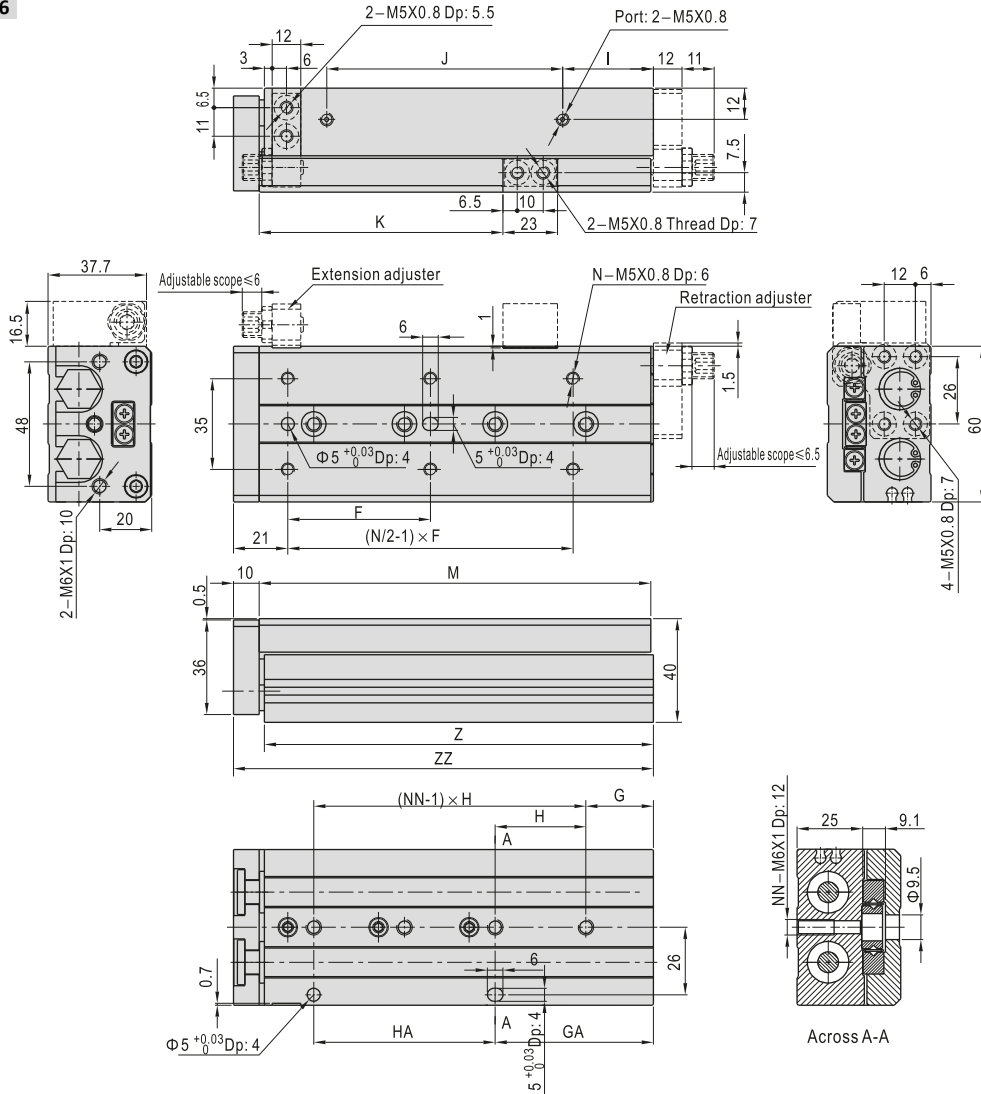

Stroke/Item	F	N	G	H	NN	GA	HA	I	J	K	M	Z	ZZ
10	35	4	16	40	2	16	40	8	42.5	28.5	76	75	87
20	35	4	16	40	2	16	40	8	42.5	38.5	76	75	87
30	35	4	16	40	2	16	40	8	42.5	48.5	76	75	87
40	40	4	16	50	2	16	50	8	52.5	58.5	86	85	97
50	30	6	21	30	3	51	30	12	63.5	68.5	101	100	112
75	55	6	26	35	4	61	70	35	90.5	93.5	151	150	162
100	65	6	39	35	5	109	70	55	118.5	118.8	199	198	210
125	70	8	19	35	7	159	70	70	153.5	143.5	249	248	260

**WLS16(With shock absorber)**

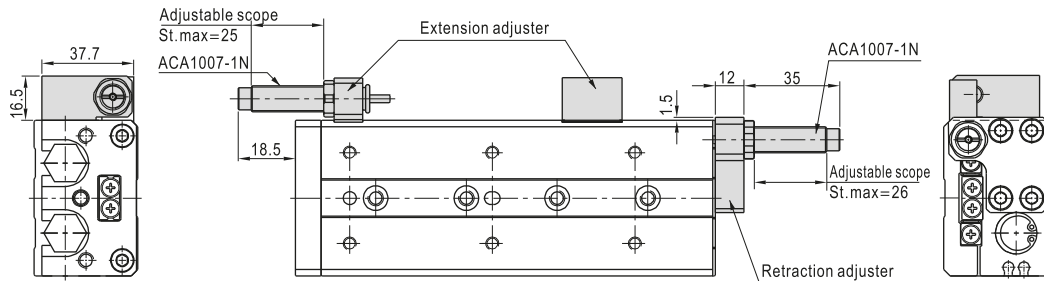

**WLS Series**

**WLS20**

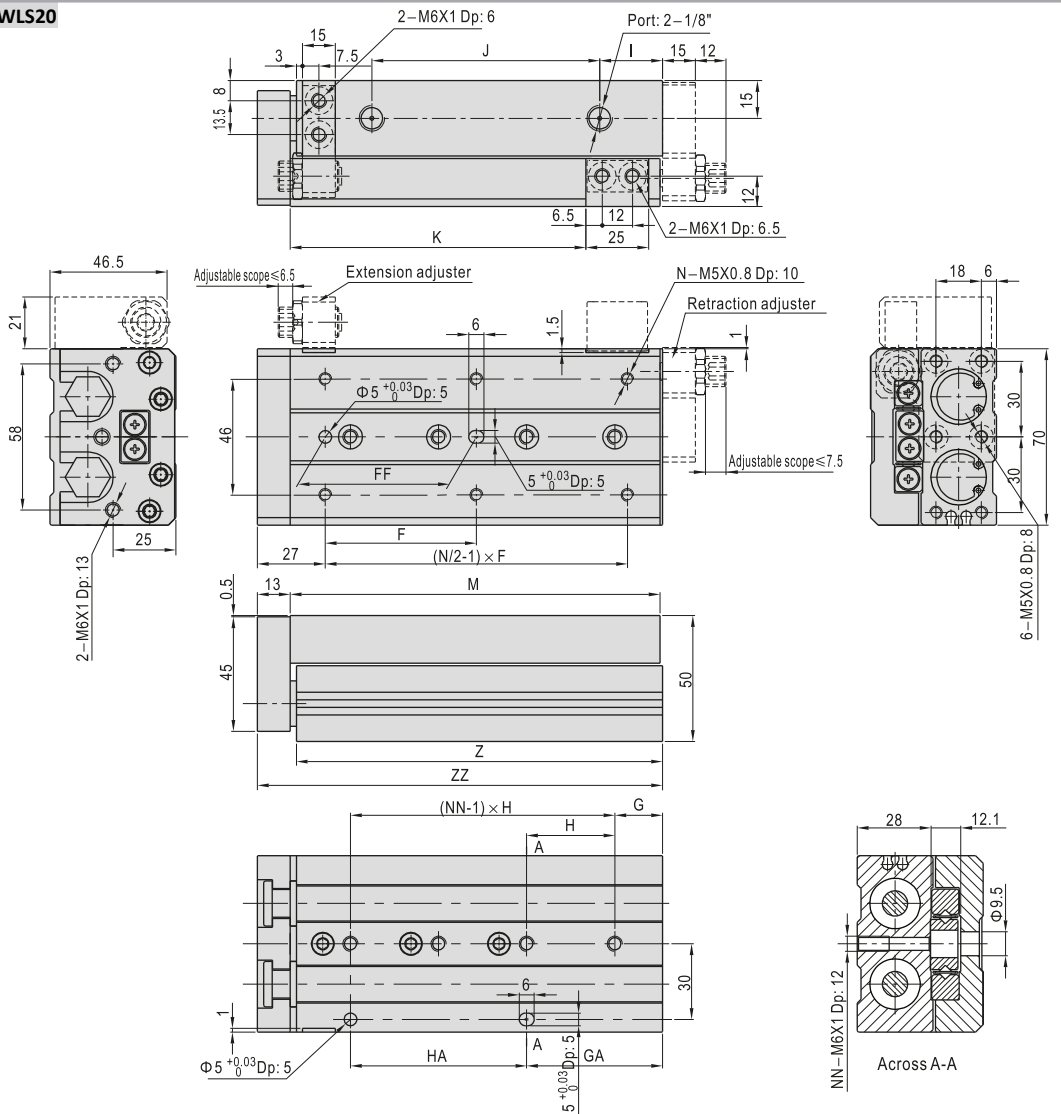

Stroke\Item	F	FF	N	G	H	NN	GA	HA	I	J	K	M	Z	ZZ
10	50	40	4	15	45	2	25	35	10	43.5	32.5	83	81.5	97
20	50	40	4	15	45	2	25	35	10	43.5	42.5	83	81.5	97
30	50	40	4	15	45	2	25	35	10	43.5	52.5	83	81.5	97
40	60	50	4	15	55	2	35	35	10	53.5	62.5	93	91.5	107
50	35	35	6	15	35	3	50	35	10	68.5	72.5	108	106.5	122
75	60	60	6	19	35	4	54	70	10	107.5	97.5	147	145.5	161
100	70	70	6	37	35	5	107	70	55	115.5	122.5	200	198.5	214
125	70	70	8	41	38	6	155	76	70	154.5	147.5	254	252.5	268
150	80	80	8	19	44	7	195	88	90	186.5	172.5	306	304.5	320

**WLS20(With shock absorber)**

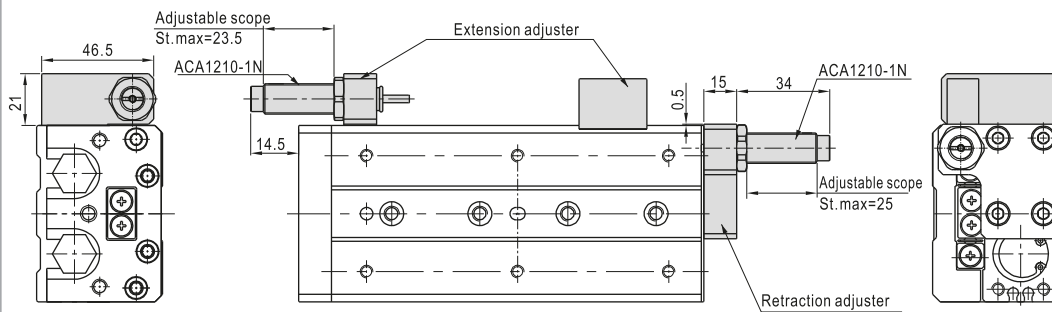

**WLS Series**

**WLS25**

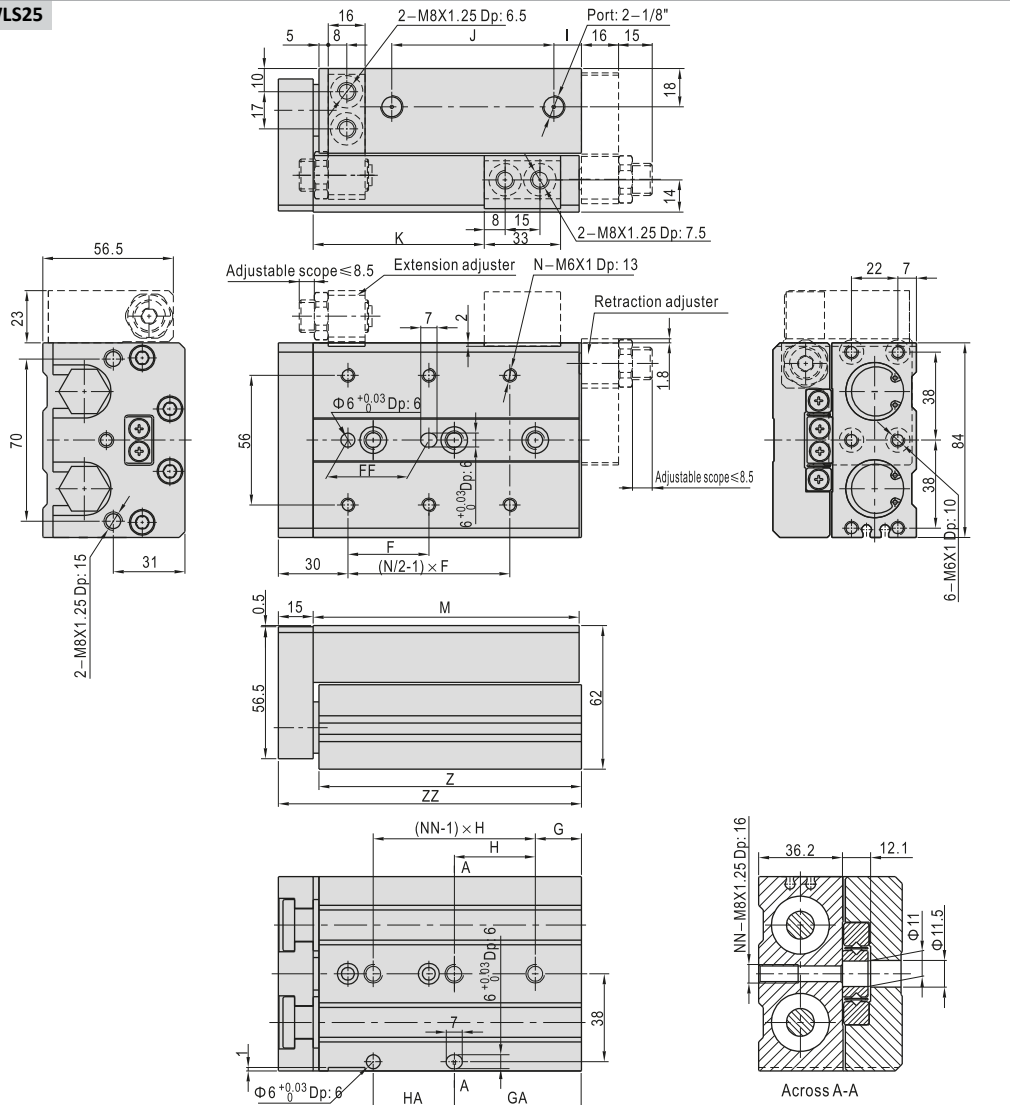

Stroke/Item	F	FF	N	G	H	NN	GA	HA	I	J	K	M	Z	ZZ
10	50	40	4	22	45	2	22	45	12	47	35	92	90.5	108
20	50	40	4	22	45	2	22	45	12	47	45	92	90.5	108
30	50	40	4	22	45	2	22	45	12	47	55	92	90.5	108
40	60	50	4	22	55	2	22	55	12	57	65	102	100.5	118
50	35	35	6	20	35	3	55	35	12	70	75	115	113.5	131
75	60	60	6	26	35	4	61	70	33	90	100	156	154.5	172
100	70	70	6	32	35	5	102	70	45	119	125	197	195.5	213
125	75	75	8	40	38	6	154	76	67	155	150	255	253.5	271
150	80	80	8	30	40	7	190	80	82	180	175	295	293.5	311

**WLS25(With shock absorber)**

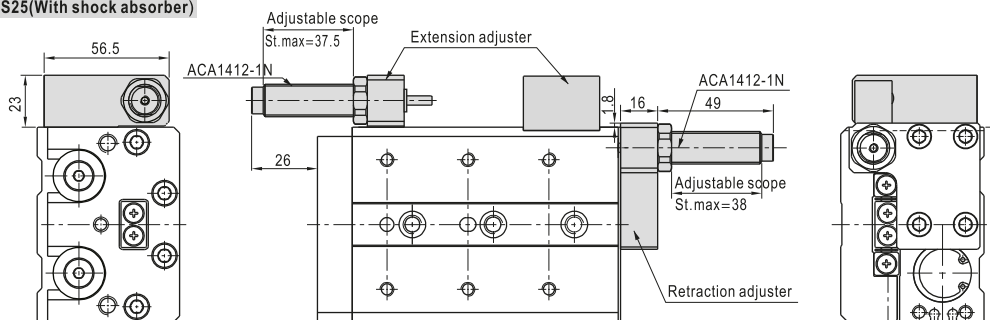



## Accessories

### Ordering code

F-WLS 20 AS	
Accessory	Accessory type ①
Model	A: Adjustable rubber stopper(Both ends) AF: Adjustable rubber stopper(Retraction)
Bore size	B: Shock absorber(Both ends) BF: Shock absorber(Retraction)

① The list accessories are for WLS cylinder. Accessories that are adaptable to other cylinder are not shown. Please refer to accessory list for selection and ordering information.

### Accessory selection

Accessories\Bore size	6	8	12
Both ends	A(Adjustable rubber stopper) B(Shock absorber)	F-WLQ6A ×	F-WLS8A F-WLS8B F-WLS12A F-WLS12B
Extention	As(Adjustable rubber stopper) BS(Shock absorber)	F-WLQ6S ×	F-WLQ8AS F-WLQ8BS F-WLQ12AS F-WLQ12BS
Retraction	AF(Adjustable rubber stopper) BF(Shock absorber)	F-WLQ6AF ×	F-WLS8AF F-WLS12AF F-WLS12BF F-WLS12BF

Accessories\Bore size	16	20	25
Both ends	A(Adjustable rubber stopper) B(Shock absorber)	F-WLS16A F-WLS20A F-WLS25A	F-WLS25A
Extention	As(Adjustable rubber stopper) BS(Shock absorber)	F-WLQ16AS F-WLQ20BS F-WLQ25BS	F-WLQ25AS
Retraction	AF(Adjustable rubber stopper) BF(Shock absorber)	F-WLS16BS F-WLS20BS F-WLS25BF	F-WLS25BF

Note): A=AS+AF; B=BS+BF.

### Dimensions

#### AS: Adjustable rubber stopper(Extention)

##### Body Mounting

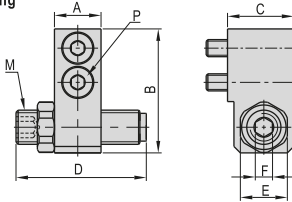

##### Table Mounting

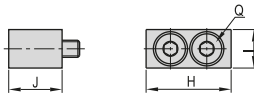

Bore size\Item	Adjusting stroke range	A	B	C	D	E	F
6	5	7	19	10.5	16.5	8	3
8	5	8.5	22	14	21.5	11	4
12	5	11	29	15.5	30.5	11	4
16	5	12	36	24	36	14	5
20	5	15	44.5	22	44.5	17	6
25	5	16	54	24	54	19	6

Bore size\Item	M	P	H	I	J	Q
6	M6 × 1.0	M2.5 Length: 10	12.5	6.5	10.5	M2.5 Length: 10
8	M8 × 1.0	M3 Length: 14	14.5	8	12	M3 Length: 14
12	M8 × 1.0	M4 Length: 16	20	9	12.5	M4 Length: 12
16	M10 × 1.0	M5 Length: 16	23	10.5	17	M5 Length: 16
20	M12 × 1.0	M6 Length: 20	25	12.5	21	M6 Length: 20
25	M14 × 1.5	M8 Length: 20	33	16.5	23	M8 Length: 20

#### AF: Adjustable rubber stopper(Retraction)

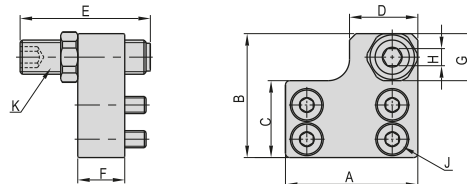

Bore size\Item	Adjusting stroke range	A	B	C	D	E	F	G	H	J	K
6	5	18	19	11	8	21.5	7	8	3	M2.5 Length: 6	M6 × 1.0
8	5	24	23.5	13	14	21.5	8.5	11	3	M3 Length: 8	M8 × 1.0
12	5	31	29	18	16	21.5	11	11	4	M4 Length: 12	M8 × 1.0
16	5	37	37.5	23	18	24	12	14	5	M5 Length: 12	M10 × 1.0
20	5	45.5	47	28.5	23	28	15	17	6	M5 Length: 16	M12 × 1.0
25	5	54	56	34	28	32	16	19	6	M6 Length: 18	M14 × 1.5

#### BS: Shock absorber(Extention)

##### Body Mounting

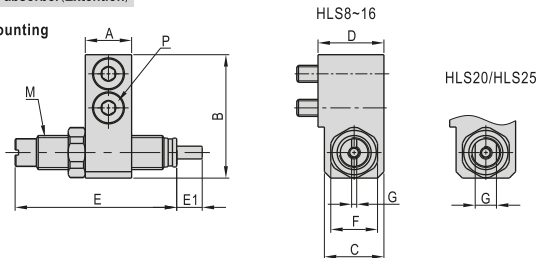

##### Table Mounting

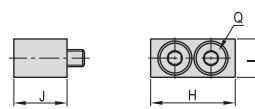

Bore size\Item	A	B	C	D	E	E1	F	G	M	P	H	I	J	Q
8	8.5	22	12.5	14	38	6	11	1.2	M8 × 1.0	M3 Length: 14	14.5	8	12	M3 Length: 14
12	11	29	14	15.5	38	6	11	1.2	M8 × 1.0	M4 Length: 16	20	9	12.5	M4 Length: 12
16	12	36	16	17.5	48	7	14	1.2	M10 × 1.0	M5 Length: 16	23	10.5	17	M5 Length: 16
20	15	44.5	20	22	50	10	17	11	M12 × 1.0	M6 Length: 20	25	12.5	21	M6 Length: 20
25	16	54	22	24	66	12	19	12	M14 × 1.5	M8 Length: 20	33	16.5	23	M8 Length: 20

#### BF: Shock absorber(Retraction)

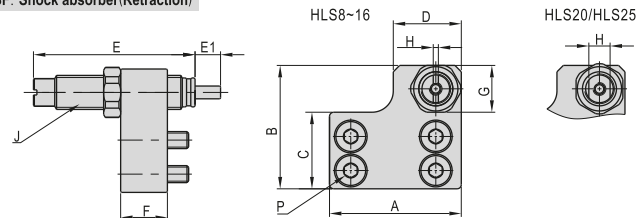

Bore size\Item	A	B	C	D	E	E1	F	G	H	J	P
8	24	23.5	13	14	38	6	8.5	11	1.2	M8 × 1.0	M3 Length: 8
12	31	29	18	16	38	6	11	11	1.2	M8 × 1.0	M4 Length: 12
16	37	37.5	23	18	48	7	12	14	1.2	M10 × 1.0	M5 Length: 12
20	45.5	47	28.5	23	50	10	15	17	11	M12 × 1.0	M5 Length: 16
25	54	56	34	28	66	12	16	19	12	M14 × 1.5	M6 Length: 18