



NEGMAK
MAKİNE HİDROLİK & PNÖMATİK

GENEL KATALOG

Pnömatik

Hidrolik

Otomasyon

Vakum

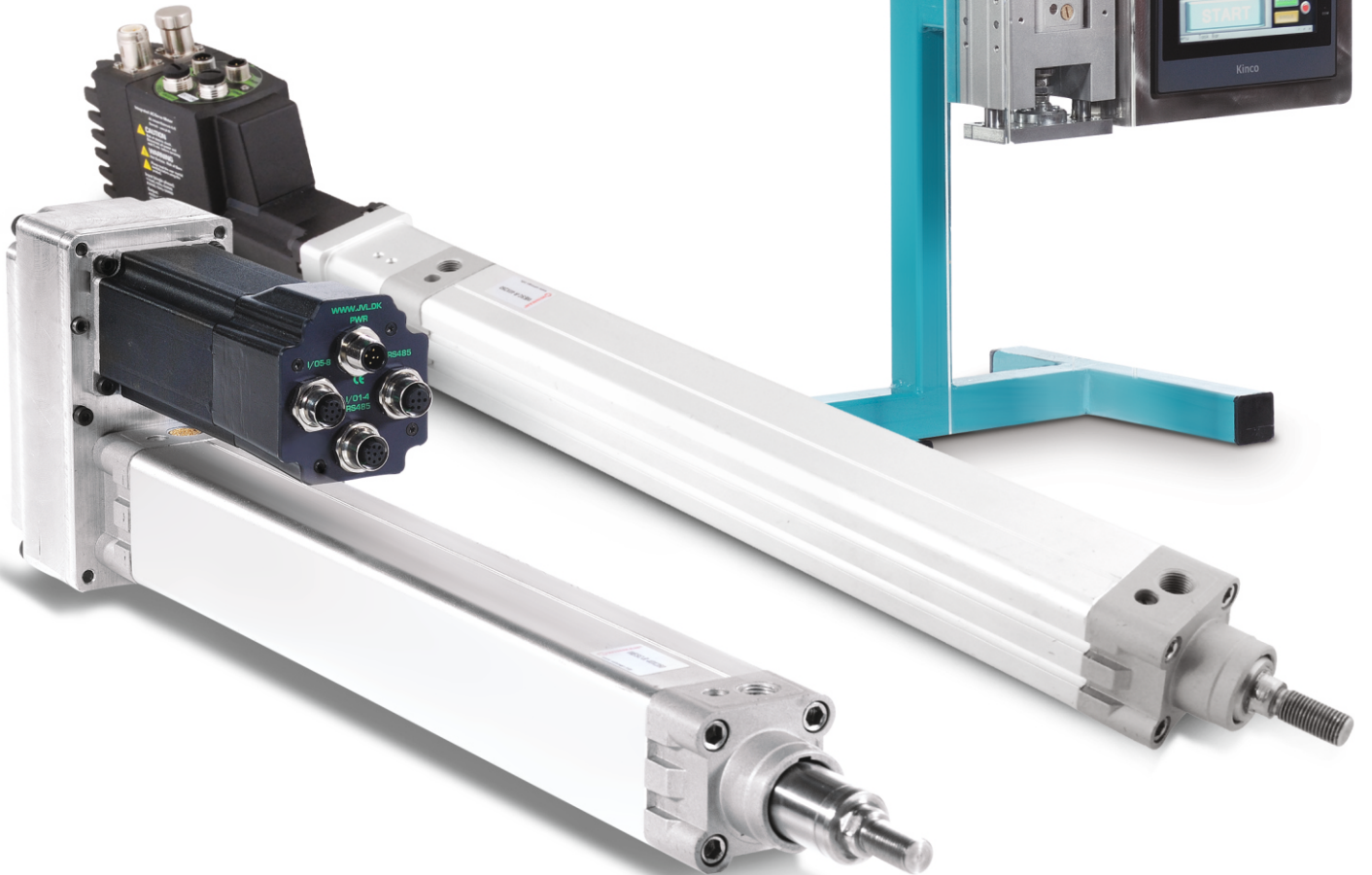

NEGMAK®

HİDROLİK - PNÖMATİK

WINMAN®

www.negmak.com.tr



İnovasyon ve gelişmeye önem veren **Neg-Mak Hidrolik Pnömatik ve Otomasyon**, sektöründe çeyrek asırlık tecrübesiyle hidrolik, pnömatik, vakum ve otomasyon sistemlerinde kullanılan WINMAN marka malzemelerin ithalatı ve satışı konusunda müşterilerine hizmet vermekte ve makine ile üretim yapan sanayi kuruluşlarına malzeme tedarik etmektedir.

Hizmet sunduğumuz firmalar arasında Türkiye'nin vakum, sanayi, alüminyum, plastik, makine imalatı (mermer, vakum paketleme, tekstil, su, elektrik-elektronik) alanlarında önde gelen firmaları yer almaktadır.

Günümüz koşullarına ayak uydurmak ve gelişimini devam ettirmek düşüncesinde olan firmamız; çalışanlarının bilgi sahibi olmalarına ve motivasyonuna önem vermektedir. Firmamız ancak çalışanları ile birlikte varlığını sürdürebileceğinin bilincinde olup, ilgili departmanımızın takibinde sürekli hizmet içi eğitimler ve iş güvenliği eğitimleri yapılmaktadır.



NEGMAK
MAKİNE HİDROLİK & PNÖMATİK

Dörtüyl Sanayi Çarşısı 9. Sk. No: 56 SAKARYA

Tel: 0 264 275 34 08 • Fax : 0 264 276 98 79

negmak@negmak.com.tr - negmak@hotmail.com

www.negmak.com.tr



NEGMAK

MAKİNE HİDROLİK & PNÖMATİK

W SERİSİ PNÖMATİK ORANSAL REGÜLATOR

Hava hazırlayıcı gruplarında yaygın olarak kullanılan standart ürünlerin dışında; **WINMAN** hassas elektronik kontrollü basınç regülasyonu, yüksek hızla tepki veren, geçirgenlikleri yüksek ve kolay kullanımı ile oransal hava regülatörleri de ürün yelpazemize katılmıştır.



ENDÜSTRİYEL HAVA HAZIRLAMA ÜNİTELERİ

Günümüzdeki CE normlarının gerektirdiği teçhizatların **WINMAN** hava hazırlayıcılarındaki uygulamalarıdır.





WINMAN WAC-YY ISO 15552 serisi silindirler



WINMAN WSI-M-YY ISO 15552 serisi silindirler



WINMAN WSB-M-YY silindirler



WINMAN WAC-HR-YY ISO 15552 serisi dönmöz milli silindirler



WINMAN WSSC-YY ISO 6432 serisi mini paslanmaz silindirler



WINMAN WSS-HRC ISO 6432 serisi dönmöz milli paslanmaz silindirler



WINMAN mikro silindirler PB



WINMAN WSAC short stroke silindirler



WINMAN WACC kompakt silindirler



WINMAN WINC kompakt silindirler



WINMAN WINC-G kompakt tablalı silindirler



WINMAN MK çoklu bağlantılı silindirler



WINMAN WGC yataklı silindirler (burçlu)



WINMAN yataklı silindirler (rulmanlı)



WINMAN TN çift milli silindirler



WINMAN STMB slide tabla silindirler



WINMAN pnömatik parmak tutucular



WINMAN H yataklama



WINMAN ACK serisi klemler



WINMAN döner klemler AS1 serisi



WINMAN AS4 serisi klemler



WINMAN RMS silindir



WINMAN LWD kartıç tip silindir



WINMAN RTA aktüatör



WINMAN yassı diyafram silindir

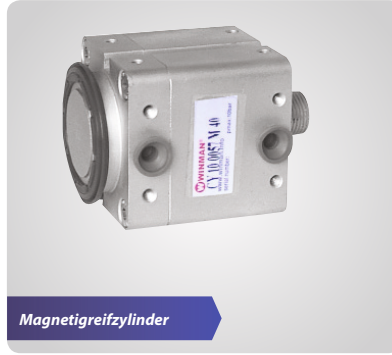

Magnetigreifzylinder



WINMAN manda gözü



WINMAN kasıntı alıcı



WINMAN CA eklem bağlantı



WINMAN eklem bağlantı



WINMAN yer bağılantı



WINMAN eklem yer bağılantı



WINMAN flanş bağılantı



WINMAN ayak bağılantı



WINMAN orta mafsal bağılantı



WINMAN P20P dijital basınç sensörü



WINMAN WT-03R serisi sensörler



WINMAN WT-07R serisi sensörler



WINMAN WT-11R serisi sensörler



WINMAN WT-40R serisi sensörler



WINMAN CS-7500R serisi sensörler



WINMAN M83R (sensör ekleme kablosu)

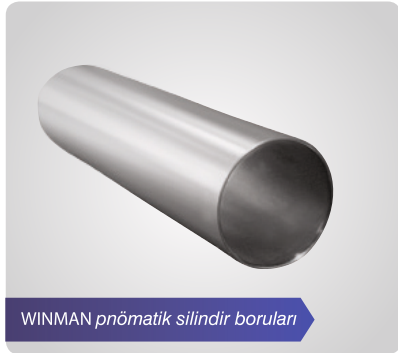

WINMAN pnömatik silindir boruları



WSS (paslanmaz çelik silindir boruları)

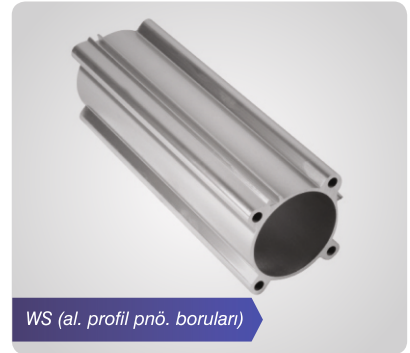

WS (al. profil pnö. boruları)



WINMAN şartlandırıcı



WINMAN üçlü şartlandırıcı



WINMAN filtre regülatör



WINMAN filtre



WINMAN regülatör



WINMAN
W Serisi Pnömatik Oransal Regülatör



WINMAN yumuşak başlatma valfleri



WINMAN kilitleli basınç emniyet valfleri



MCS200 serisi multi connector



WINMAN tek bobin valfler



WINMAN çift bobin valfler



WINMAN namur pnömatik valfler



WINMAN ISO serisi pnömatik valfler



WINMAN manifoldlar



WINMAN ISO serisi manifoldlar



WINMAN hava - yay pnömatik valfler



WINMAN hava - hava pnömatik valfler



WINMAN kol kumandalı pnömatik valfler



WINMAN çekmeli pnömatik valfler



WINMAN pedal kumandalı pnömatik valfler



WINMAN mekanik kontrollü pnömatik valfler



WINMAN 4HV230 serisi valf



Aktüatör Vana



WINMAN 2W serisi selenoid valf



WINMAN booster



WINMAN paslanmaz pistonlu vanalar



WINMAN komple paslanmaz pistonlu vana



WINMAN ayarlanabilir şok emiciler (FC)



WINMAN sabit şok emiciler (SC)



WINMAN HSV serisi kayar valf



WINMAN hat tipi pilotlu kilitleme



WINMAN Pnömatik Pilotlu Kilitleme



WINMAN hat tipi hız ayar valfleri

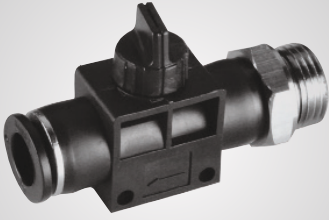

WINMAN HVSF dişli hortum vana



WINMAN hat tipi hız ayar bağlantı



WINMAN dirsek hız ayar



WINMAN 90° dirsek hız ayar



WINMAN nipel tipi çekvalf



WINMAN NRC yüksek hızlı döner rekor



WINMAN poliüretan hortumlar



WINMAN stop rekor



WINMAN çabuk egzost



WINMAN metal rekor bağlantı



WINMAN hava tabancaları



WINMAN metal dirsek bağlantı



WINMAN metal TE bağlantı



WINMAN paslanmaz bağlantı elemanları



WINMAN paslanmaz dirsek bağlantı



WINMAN paslanmaz TE bağlantı



WINMAN paslanmaz nipel bağlantı



WINMAN IBC metal sıkımalı rekor bağlantılar



WINMAN IBV metal sıkımalı dirsek bağlantılar



WINMAN IBT metal sıkımalı orta bacak TE



yüksüklü rekor, yüksüklü dirsek



yüksüklü TE, yüksüklü nipel



WINMAN egsoz kısıcı-İSD



WINMAN BSL serisi susturucular



WINMAN BSLM serisi susturucular



WINMAN PSU serisi susturucular



WINMAN ST serisi susturucular



NEGMAK
MAKİNE HİDROLİK & PNÖMATİK

YAĞ SOĞUTMA SİSTEMİ

WINMAN markası olarak hava emiřli hidrolik yađ tutucuları üretimimize de iddialıyız.

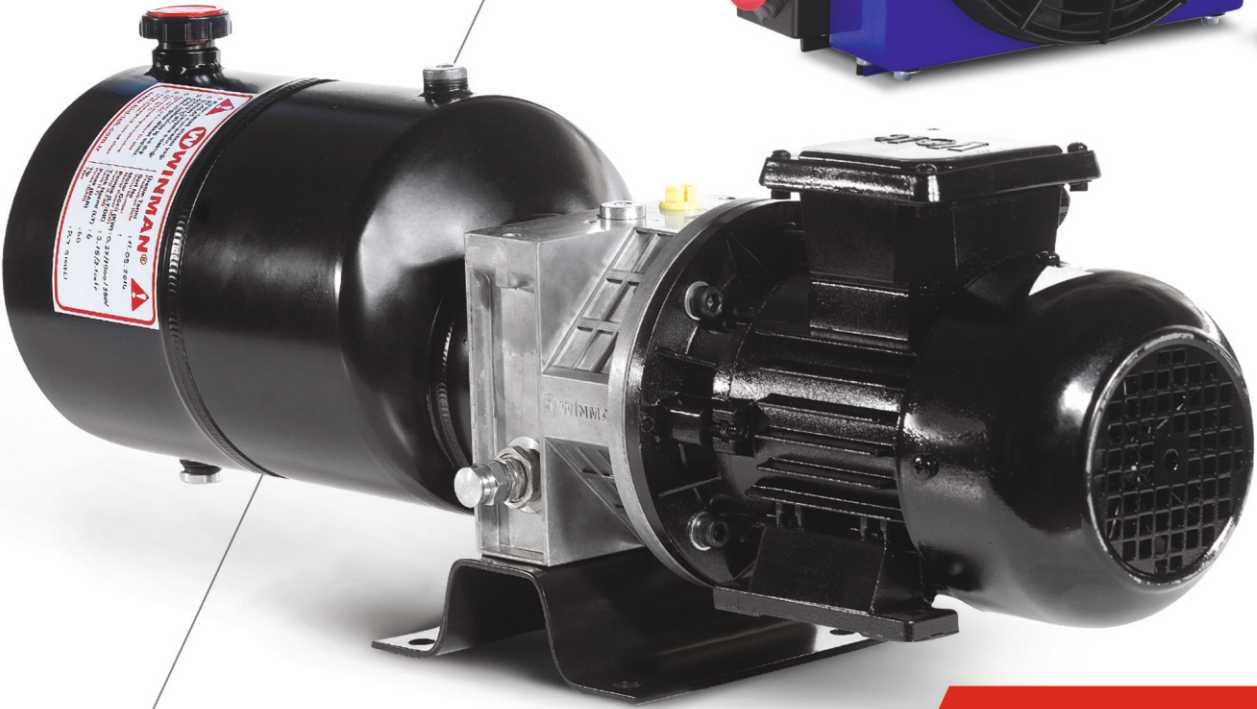

POWERPACK

Hidrolik güç ünitesi gereksiniminde teslimatta hız ve kullanımda çeřitlilik taleplerine cevabımız Powerpack'ler olacaktır.

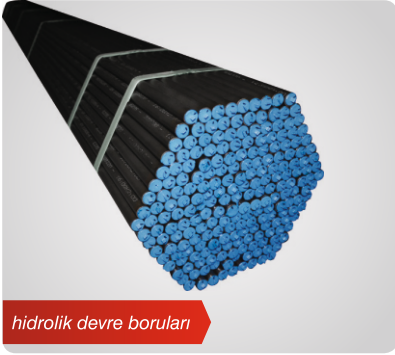

hidrolik devre boruları



döküm miller



honlanmış borular



WINMAN OS1 klempler



WINMAN OS2 klempler



WINMAN hidrolik short stroke silindirler



WINMAN hidrolik hız regülatörleri



WINMAN NG6 - NG10 selenoid valfler



WINMAN NG16-20-32 hidrolik valf blokları



WINMAN oransal kontrollü valfler



WINMAN QPG-QPE lojik oransal valfler



WINMAN EBG 03 oransal emniyet valf



WINMAN PPG oransal emniyet valfi



WINMAN QPG oransal hız ayar valfi



WINMAN DPG oransal yön valfi



NEGMAK

MAKİNE HİDROLİK & PNÖMATİK

HİDROLİK GÜÇ ÜNİTESİ VE STANDART HİDROLİK SİLİNDİRLER

WINMAN kalitesiyle üretilen standart hidrolik silindirler ve hidrolik klempler yüksek hız, düşük basınç, yüksek basınç, fiziksel yapısı vs. gibi özellikleriyle kullanım alanlarına göre özel imal edilmektedir. Ayrıca endüstriyel, mobil ve tarım makinaları sektörüne özel üretim de yapılmaktadır. Hidrolik Güç Üniteleri gerekli projelendirmelerden sonra çeşitli versiyonlarla üretilmektedir.

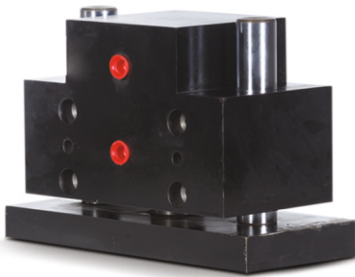



WINMAN oransal kart



WINMAN hidrolik silindir



WINMAN modüler hız ayarlar



WINMAN modüler kilitlemeler



WINMAN modüler emniyetler



WINMAN modüler çekvalf



WINMAN modüler pilotlu kilitleme



WINMAN modüler basınç düşürücüler



WINMAN modüler emniyet ve karşı denge valfi



WINMAN modüler hız ayar valfi



WINMAN hat tipi basınç emniyet valfi



WINMAN pleyt tipi basınç emniyet valfi



WINMAN pleyt tipi basınç emniyet valfi sıfırlamalı



WINMAN valf blokları



WINMAN emniyetli valf blokları

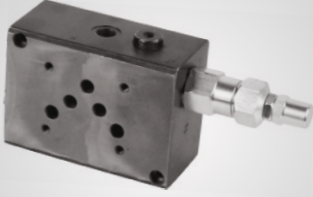

WINMAN NG10 tekli emn çelik valf pleytleri



WINMAN lojik valfler

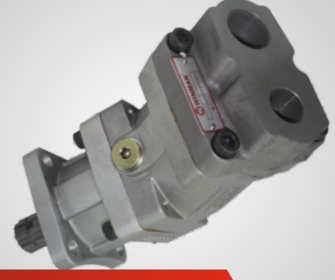

WINMAN Axial Pistonlu Pompa



WINMAN paletli pompalar



WINMAN değişken debili paletli pompalar



WINMAN değişken debili axial pistonlu pompalar



WINMAN PV hidrolik güç regülasyonlu pistonlu pompalar



WINMAN değişken debili axial pistonlu pompalar-v serisi

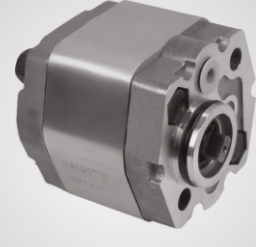

WINMAN power pack pompaları

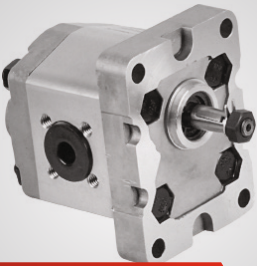

WINMAN grup 1 dişli pompalar



WINMAN grup 2 dişli pompalar

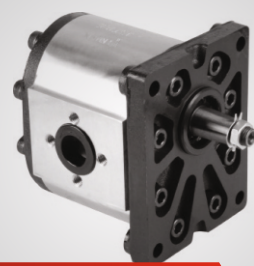

WINMAN grup 3 dişli pompalar



WINMAN dişli tandem pompa

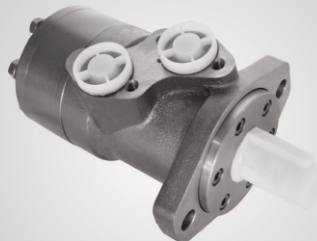

WINMAN hidromotorlar

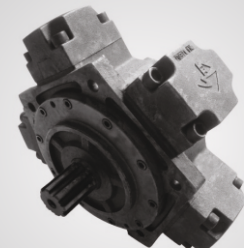

WINMAN ITM radial pistonlu motor



WINMAN PP basınç şalterleri



WINMAN hidrolik kumanda kolları



WINMAN AC-DC hidrolik power pack



WINMAN kaplin



WINMAN popet valf



WINMAN hat tipi platform valfi



WINMAN hat tipi yük tutma tekli



WINMAN hat tipi yük tutma ikiz



WINMAN hat tipi yük tutma silindir üstü montajı



WINMAN modüler yük tutma tekli



WINMAN modüler yük tutma ikiz



WINMAN basınç sıralama valfi



WINMAN motor tipi yük tutma



WINMAN LP1-A3 basınç şalterleri



WINMAN hat tipi direkt emniyet valfi



WINMAN hat tipi ikiz emniyet valfi



WINMAN bobin



WINMAN hat tipi basınç düşürücü



WINMAN hidromotor montajlı ikiz emniyet



WINMAN hat tipi tandem sıfırlama valfi

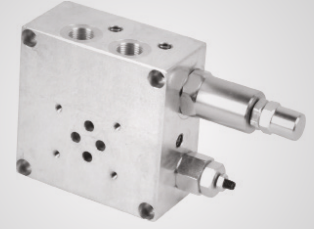

WINMAN modüler tandem sıfırlama valfi

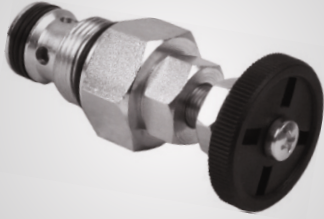

WINMAN hız ayar kartrici



WINMAN 3 yollu basınç duyarlı hız ayar

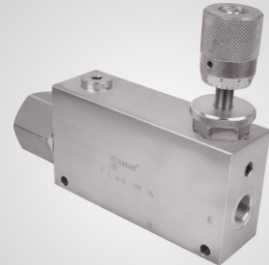

WINMAN üç yollu akış bölücü valf



Kaplinler



WINMAN hat tipi hız ayar valfi



WINMAN hidrolik kırıcı valfler

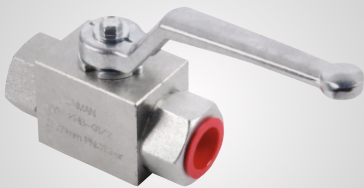

WINMAN KHB hidrolik küresel vana 2 yollu

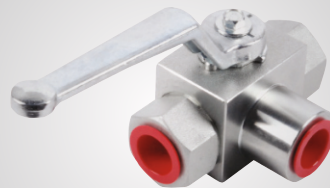

WINMAN 3 yollu küresel vana



WINMAN 3 yollu küresel vana



NEGMAK

MAKİNE HİDROLİK & PNÖMATİK

MAGIC CUP

Tutulamayan yüzeyleri tutabilen, iz bırakmasını istemediğimiz yüzeylerde farklı stoper imkanı sunan ve kullanıcıyı bakım maliyetlerinden koruyan değişken uç yapısı mevcuttur.



SMART SUCTION CUP

Vakum teknolojisinin geldiği son nokta olarak görebileceğimiz ürün, aşıl yüzeyleri tutabilme, kot farklarını absorbe etme ve vantuzun yıpranması durumunda elle sökülebileme imkanı sunmaktadır.



VSA SİSTEM

Robot uygulamaları için mükemmel çözüm imkanı sunan mafsal sistemi, 360 dereceyi 20 eşit parçaya bölen farklı konumlama imkanına sahiptir. Kavisli ve yüzey farklılıklarına sahip parçaları tutmada kolaylık sağlar. Vantuzların yıpranması durumunda da elle sökülebileme imkanı sunmaktadır.



vakum kartrici



VTX-MINI vakum pompası



VTM-KD duplex vakum pompası



VTRF vakum pompası



hat tipi vakum pompası



midiflex vakum pompası



turtle pompa



vakum adası



seviye yaylı vakum pompası



hızlı vakum modülü (VSM)

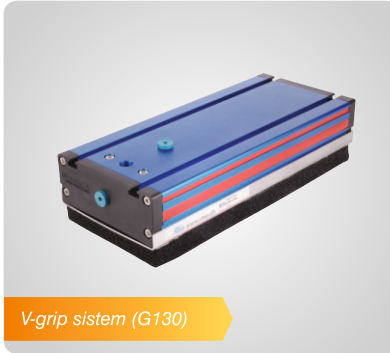

V-grip sistem (G130)



vamlock seviye yaylı



temassız vakum enjektörü



vakum konveyörü



VTRF vakum pompası



NEGMAK
MAKİNE HİDROLİK & PNÖMATİK

LİNEER HAREKET MODÜLLERİ

Makinelerinizde, hareket eksenlerini kompakt tasarımlarımızla standart hale getirebilir, bağlantı ekipmanlarıyla sistemlerinize kolay adapte edebilirsiniz.

Farklı yataklama seçenekleriyle yük kapasitelerinize uygun seçimler yaparken, triger kayış ve vidalı milli tahrik seçeneklerimizle konumlama hassasiyetleriniz ve maliyetleriniz arasında optimum bir denge oluşturabilirsiniz.

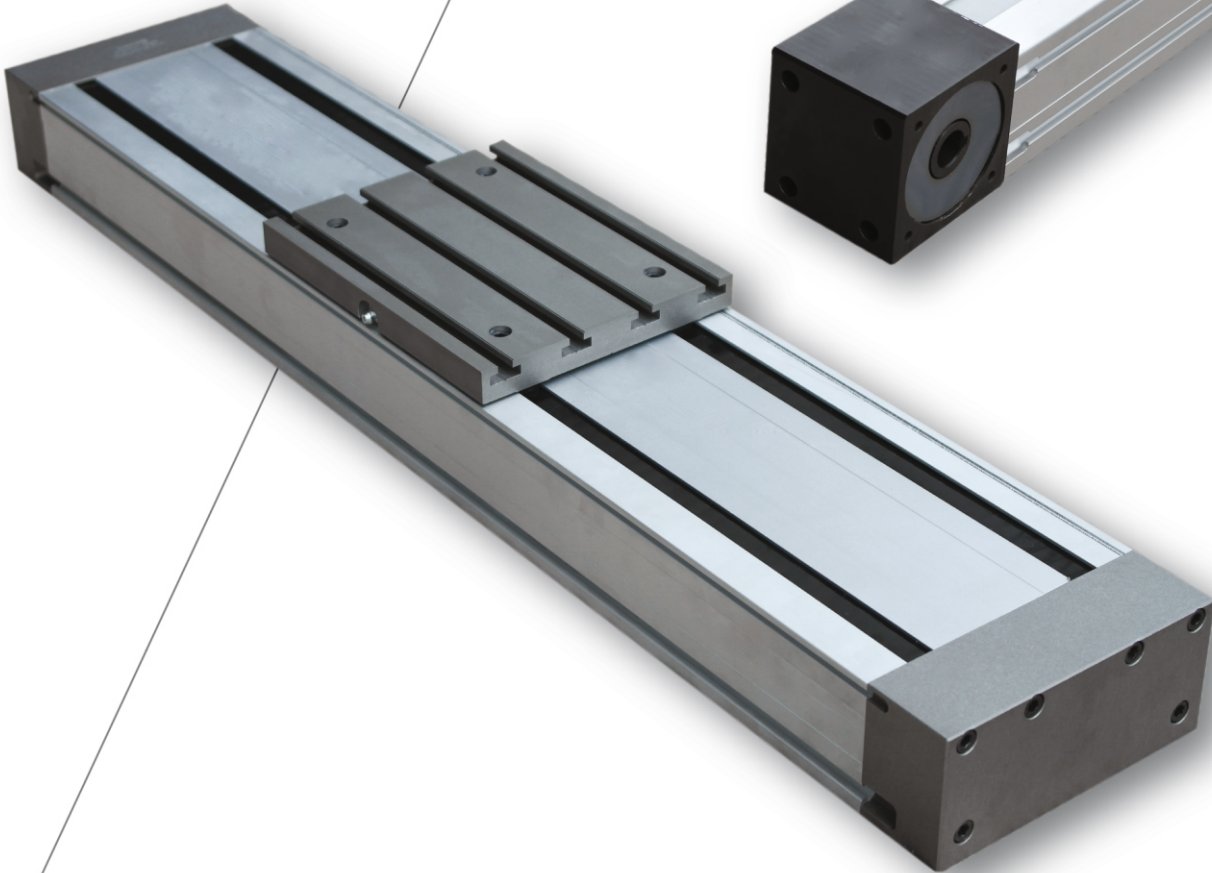



MSC serisi, minyatür tip araba



WFL - CC serisi araba

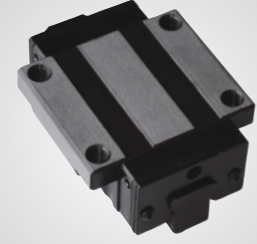

WFL - HC serisi araba



WGL - CA serisi araba



WGL - HA serisi araba

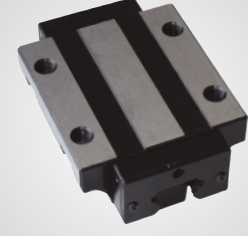

WFR - TC serisi araba

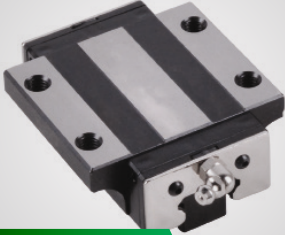

WFR - SC serisi araba

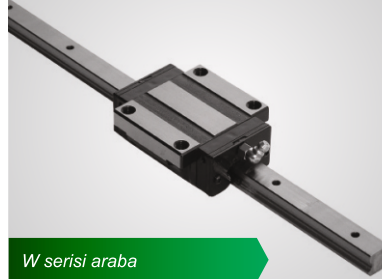

W serisi araba



Lineer Elemanlar



Motor Kaplinleri



bilyalı somun



vidalı mil



Planet Dişli Redüktör



Vidalı Milli Lineer Sistem

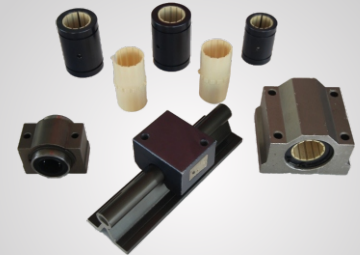

Yağsız Lineer Elemanlar



WINMAN
vidalı milli lineer modüler yatay yük



WINMAN
triger kayışlı modüler dikey yük



WINMAN
vidalı milli lineer modüler dikey yük



WINMAN
triger kayışlı modüler yatay yük



WINMAN MC serisi triger kayışlı uygulama



WINMAN kayış tutuculu uygulama

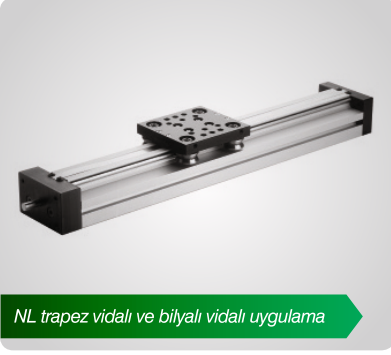

NL trapez vidalı ve bilyalı vidalı uygulama



AKR 20 hassas raylı uygulama



WINMAN Lineer Aktüatör



WINMAN Lineer Aktüatör



CI ray

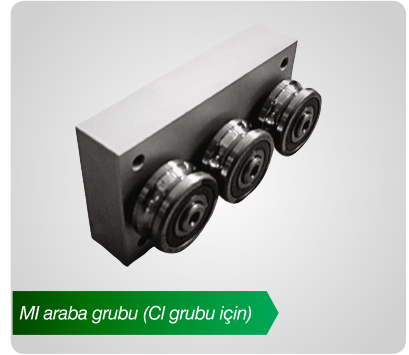

M1 araba grubu (CI grubu için)



Lineer Hareket Modülleri



Lineer Hareket Modülleri

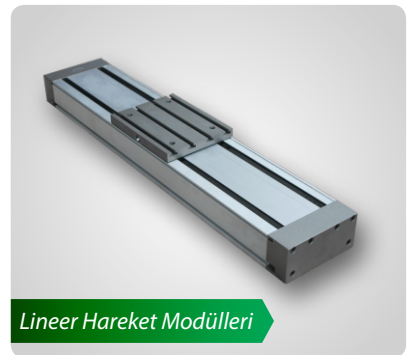

Lineer Hareket Modülleri



NEGMAK

MAKİNE HİDROLİK & PNÖMATİK

WINMAN LİNEER TEKNOLOJİ AKILLI ÜRÜN VE SİSTEM ÇÖZÜMLERİ

WINMAN Lineer Kılavuzlama Sistemleri yüksek rijitliği ve yük katsayılarına sahip bilyalı veya masuralı lineer yataklardır. Bu kılavuz sistemleri hareket yönü hariç tüm yönlerdeki kuvvetleri ve tüm eksenlerdeki momentleri karşılayabilirler.

Bu üniteler, X-life kalitesine göre optimize edilmiş düşük gürültüye sahip tasarımla da sunulmaktadır.

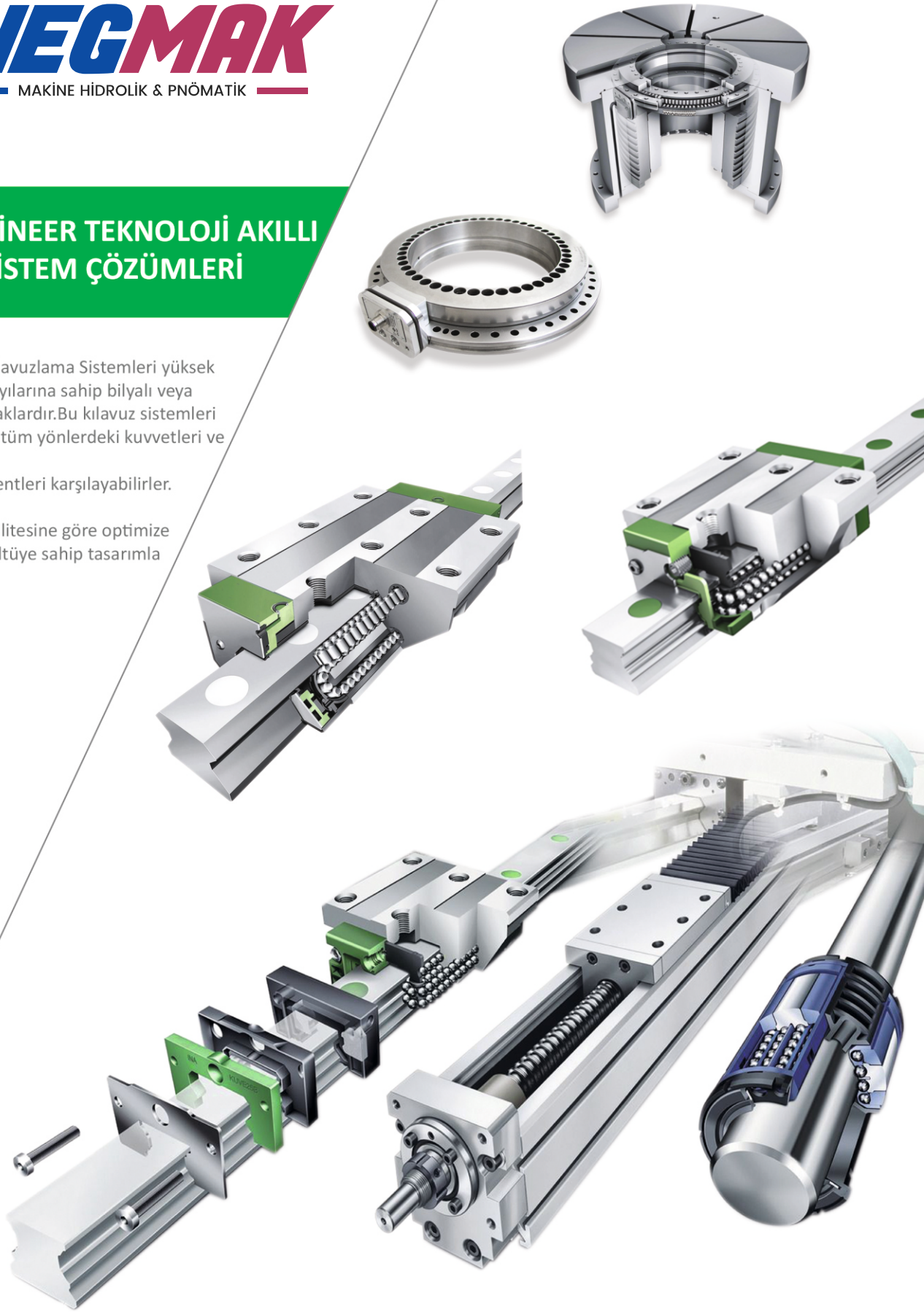

HİDROLİK GÜÇ ÜNİTESİ VE STANDART HİDROLİK SİLİNDİRLER



ENDÜSTRİYEL HAVA HAZIRLAMA ÜNİTELERİ



SMART SUCTION CUP

LİNEER MODÜL, LİNEER ARABA VE RAY

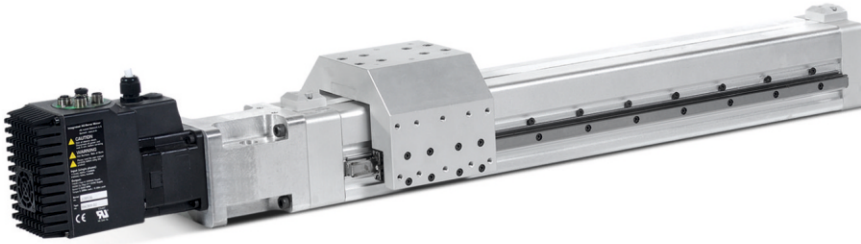

MAGIC CUP



NEGMAK
MAKİNE HİDROLİK & PNÖMATİK

Dört Yol Sanayi Çarşısı 9. Sk. No: 56 SAKARYA
Tel: 0 264 275 34 08 • Fax : 0 264 276 98 79
negmak@negmak.com.tr - negmak@hotmail.com
www.negmak.com.tr



www.kosgeb.gov.tr
Basım Tarihi: 27/09/2018
1000 adet basılmıştır
ADARENK MATBAA VE GRAFİK HİZ.
Ayşe Kiliç